



Инструкция по установке

Toyota Land Cruiser 200

(2007-)

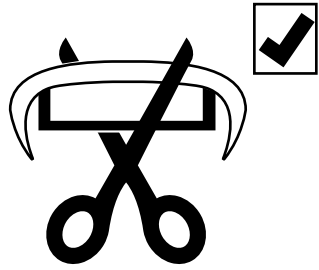

Арт.: F.5703.006

 <p>2500 kg</p>	 <p>120 kg</p>	<p>D = 14,04 kN</p>	
---	--	----------------------------	---

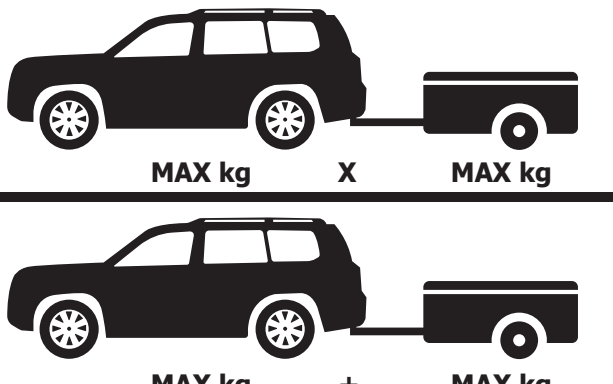
<p>D (kN) =</p>	 <p>MAX kg X MAX kg</p> <p>MAX kg + MAX kg</p>	<p>x 0,00981</p>
------------------------	--	-------------------------

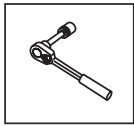

Вкрутить/выкрутить используя инструмент

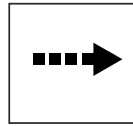

Движение

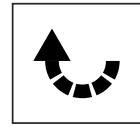

Поворот



Вкрутить/выкрутить не затягивая

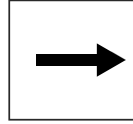





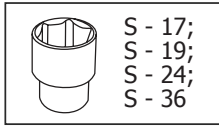
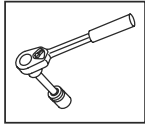



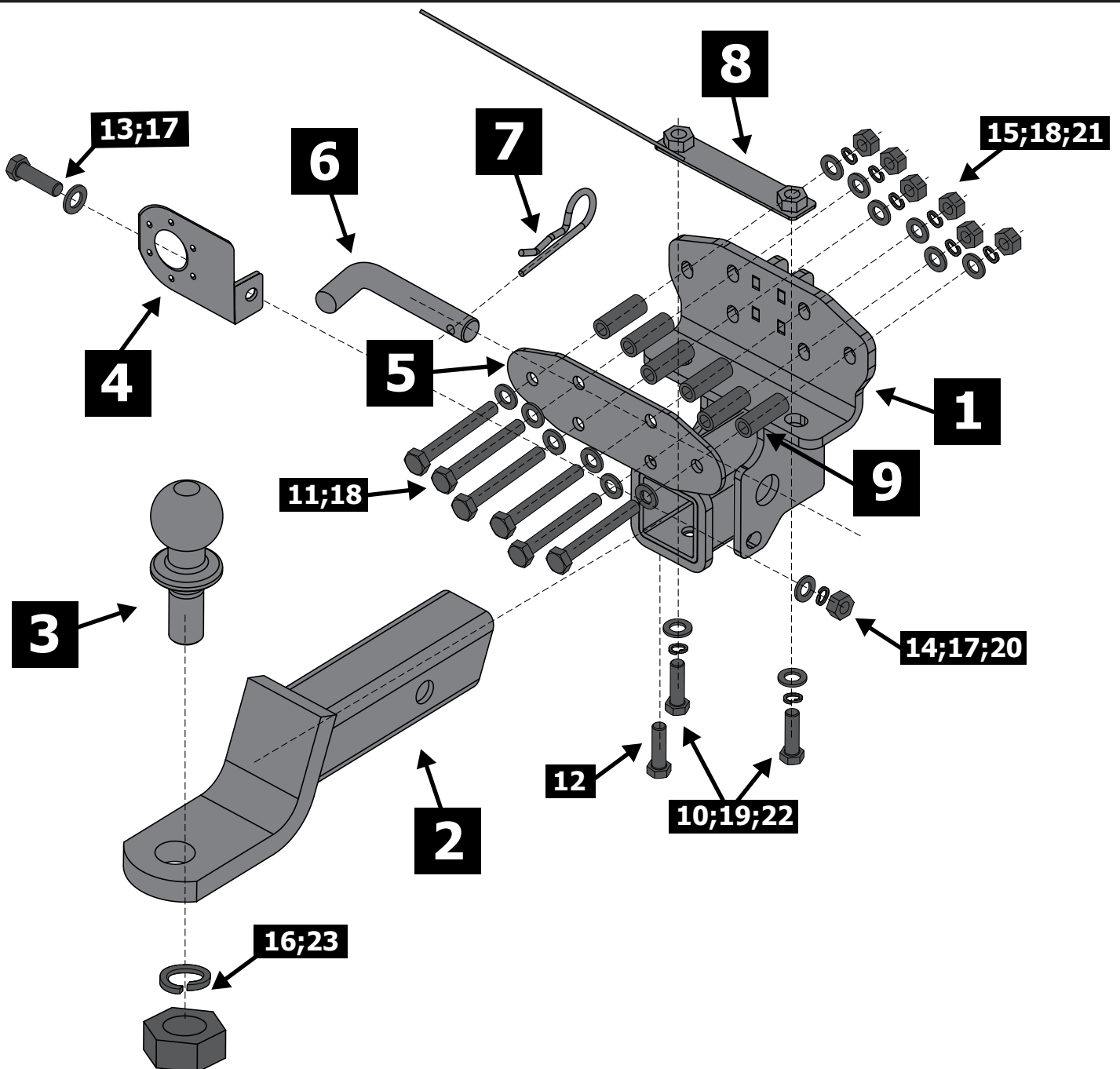
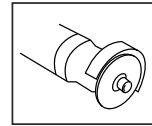
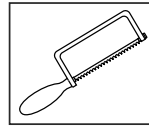
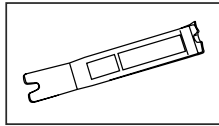





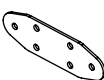



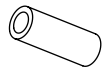
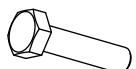

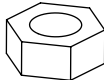

Расположение

Используемый инструмент:



S - 17;
S - 19;
S - 24;
S - 36



1	x1	Кронштейн	
2	x1	Адаптер	
3	x1	Шар	
4	x1	Подрозетник	
5	x1	Пластина прижимная	
6	x1	Штифт	
7	x1	Шплинт пружинный	
8	x1	Гайка закладная	
9	x6	Втулка	
10	x2	M16x60	
11	x6	M12x110	
12	x1	M10x20	
13	x1	M10x30	
14	x1	M10	
15	x6	M12	
16	x1	M24	
17	x2	Ø10	
18	x12	Ø12	
19	x2	Ø16	
20	x1	Ø10	
21	x6	Ø12	
22	x2	Ø16	
23	x1	Ø24	

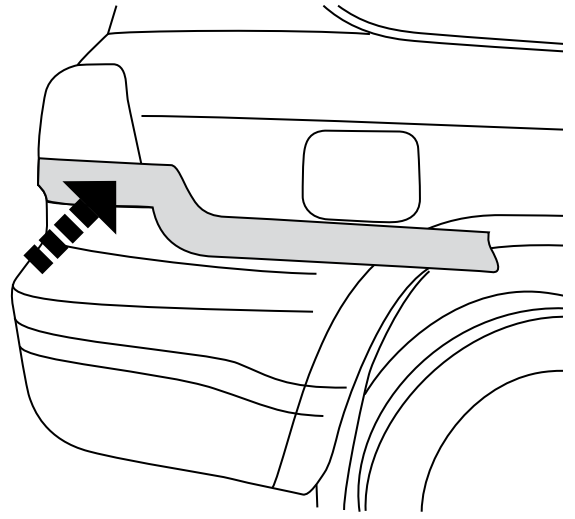
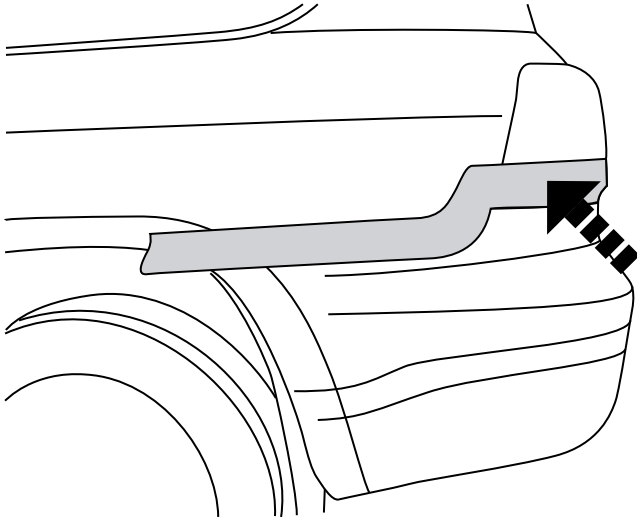
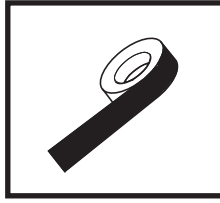
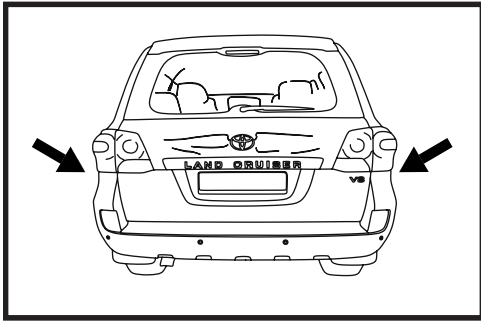

1

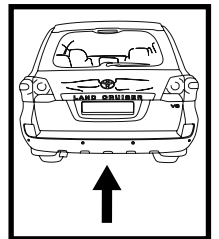
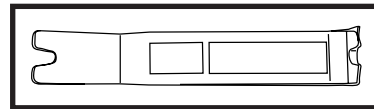
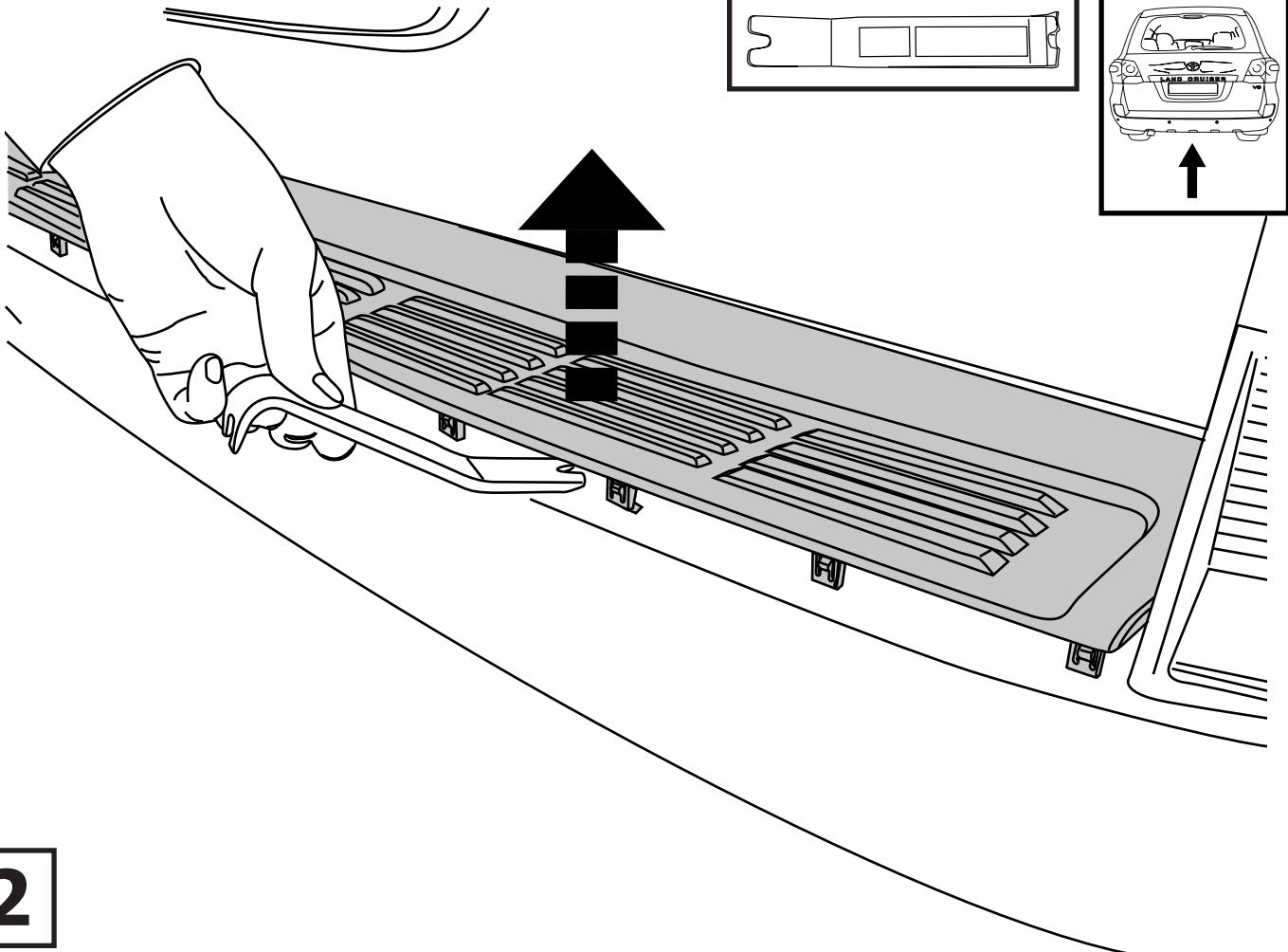

2

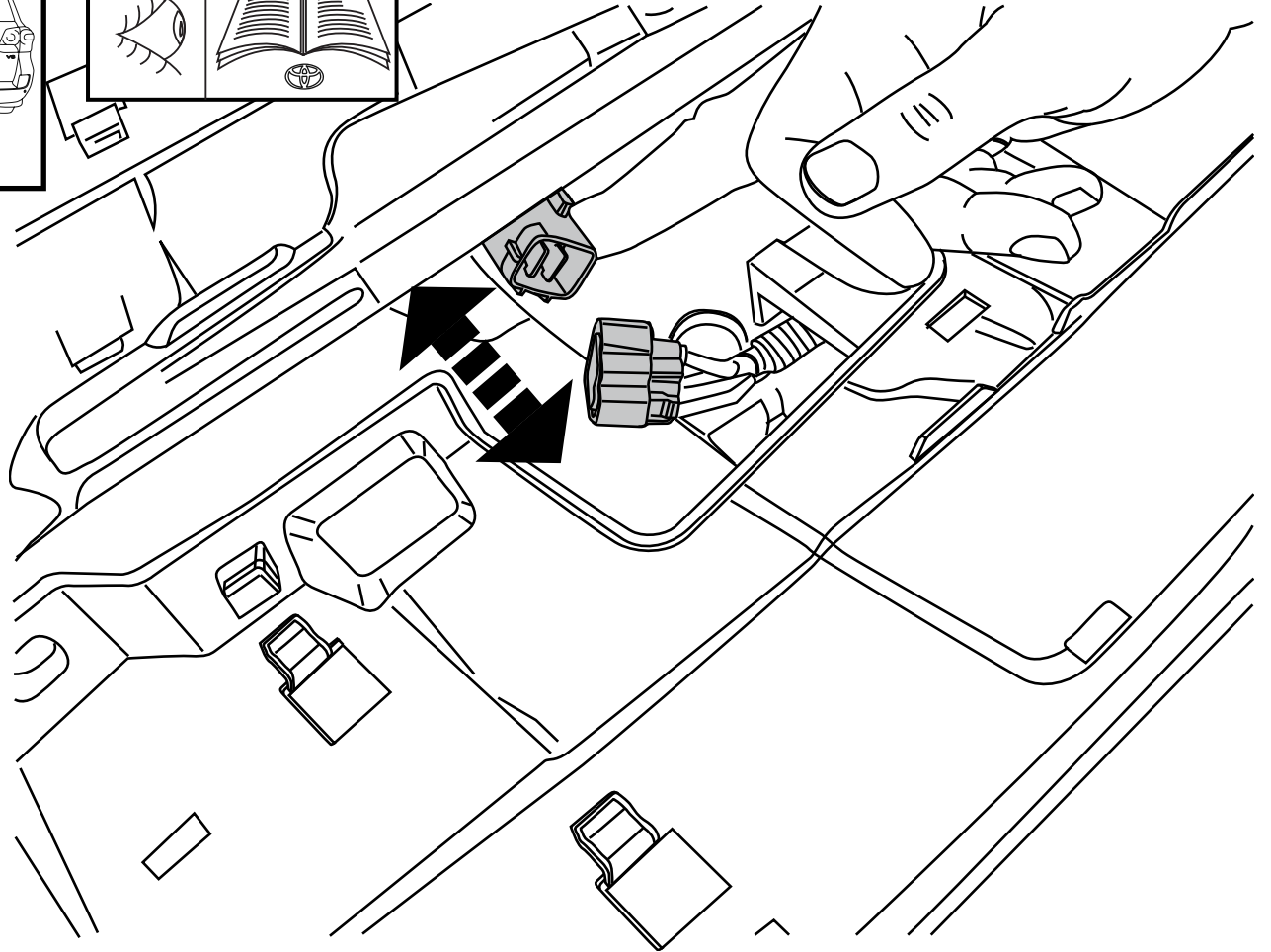
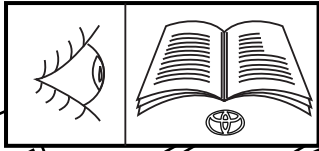
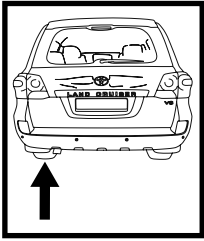

3

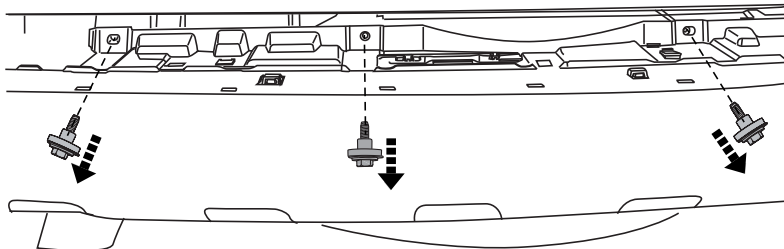
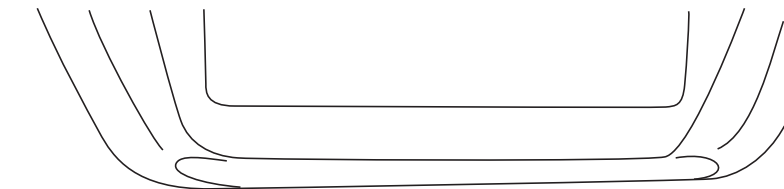
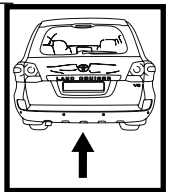
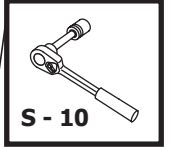
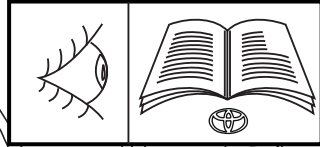
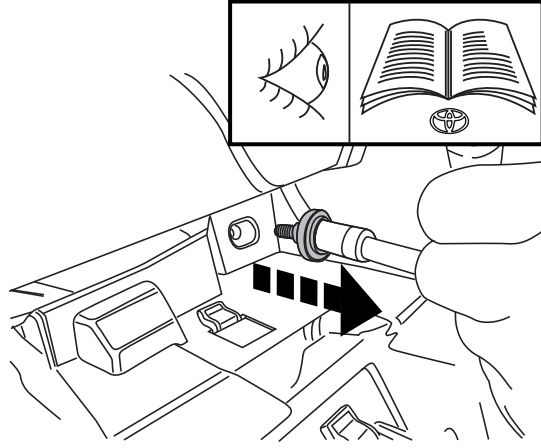
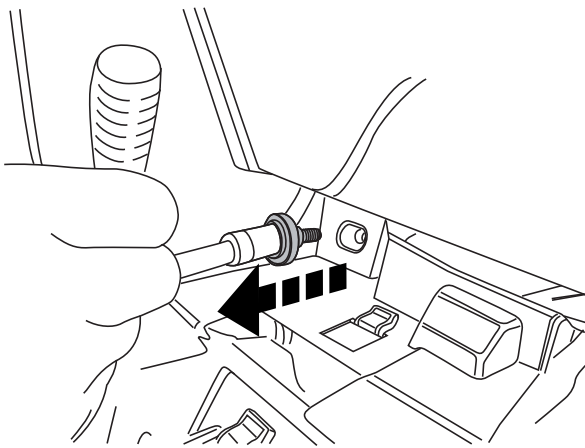

4

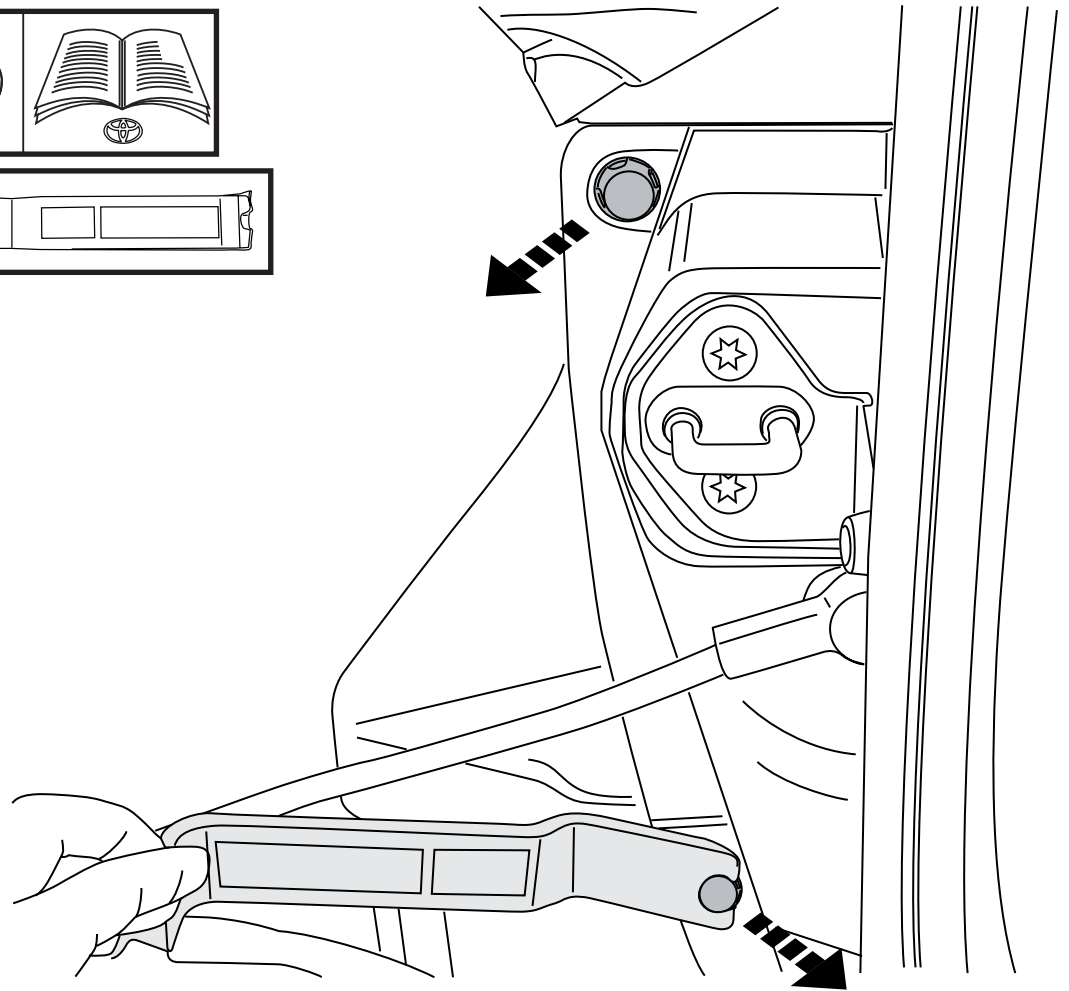
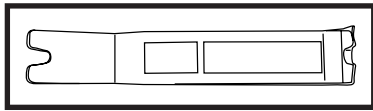
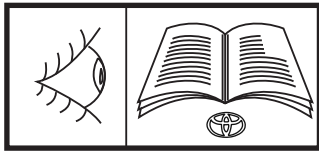
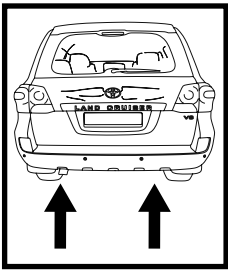

5

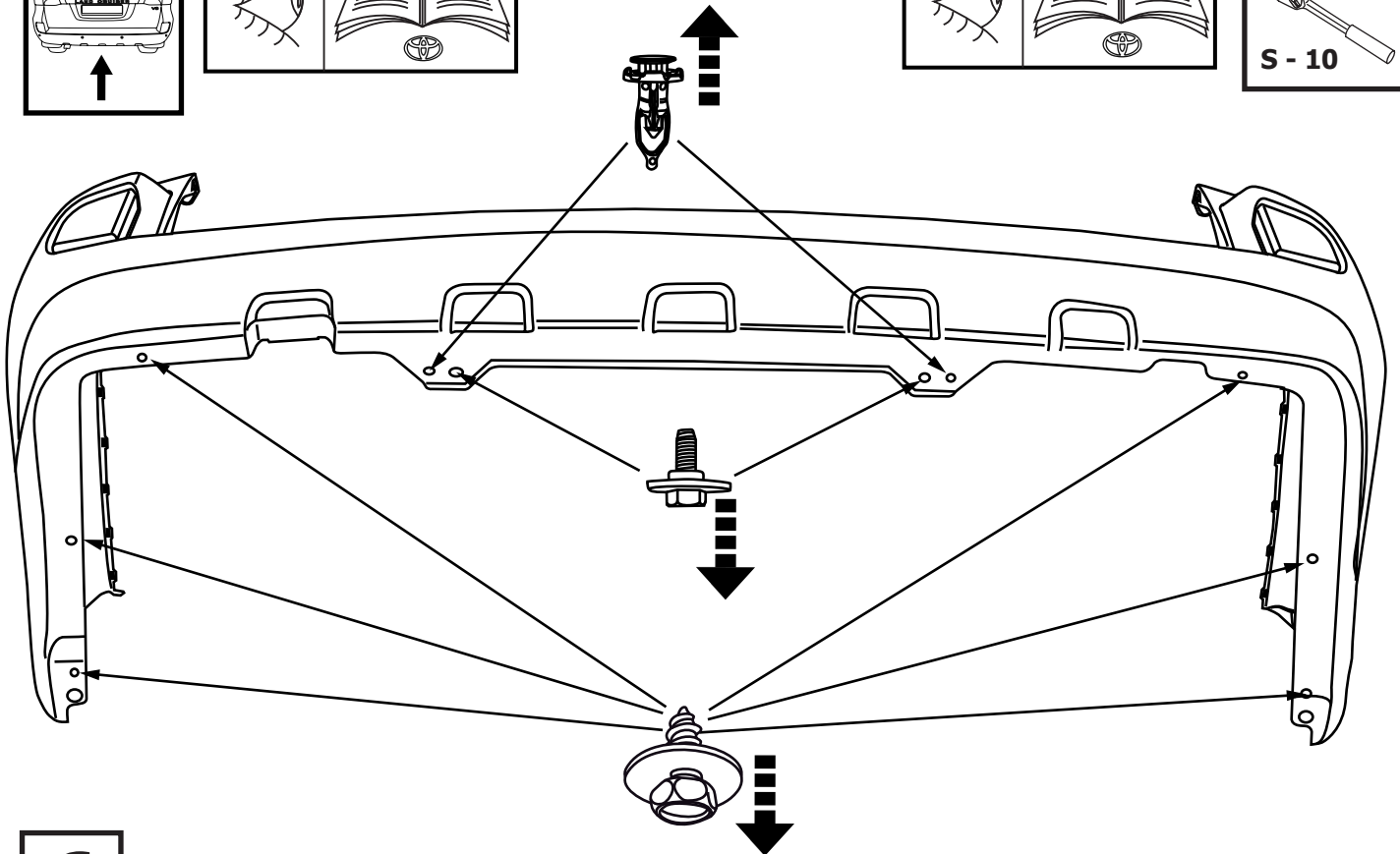
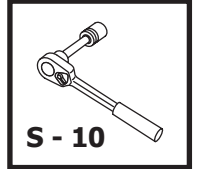
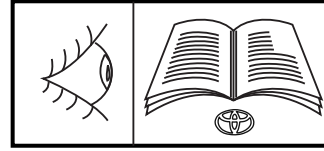
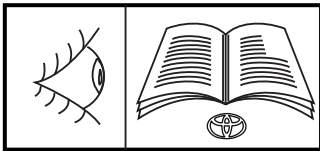
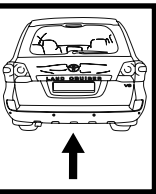

6

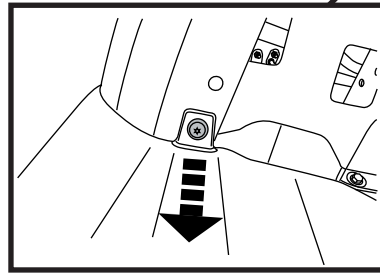
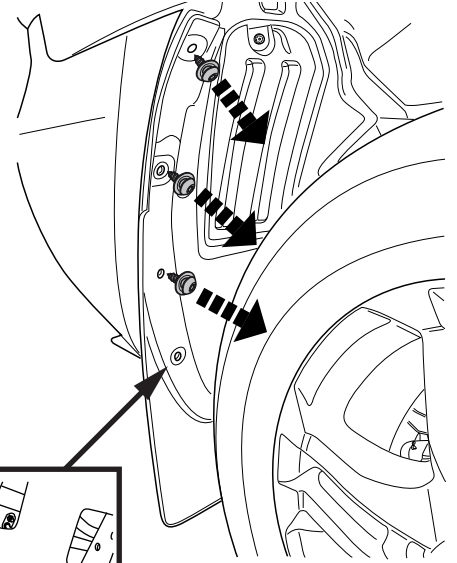
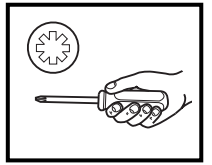
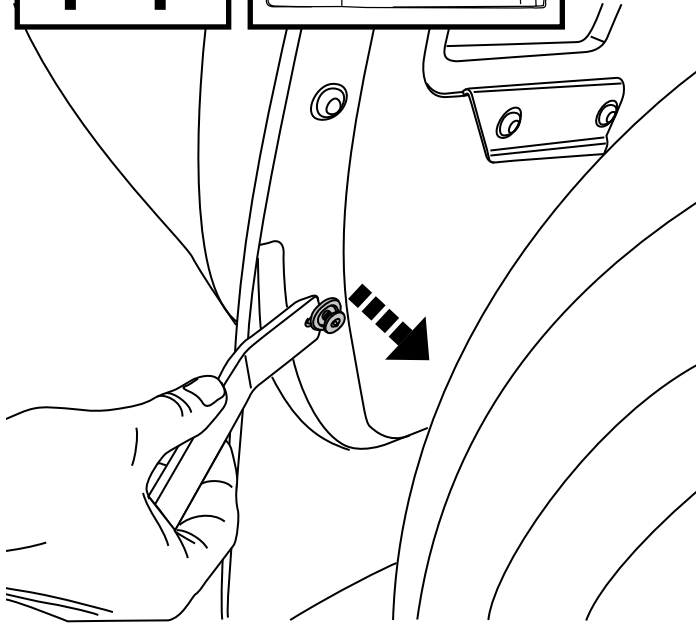
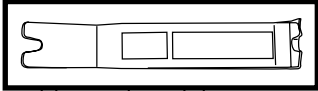
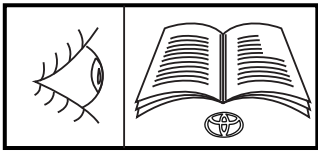
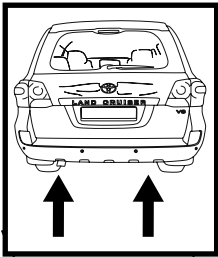

7

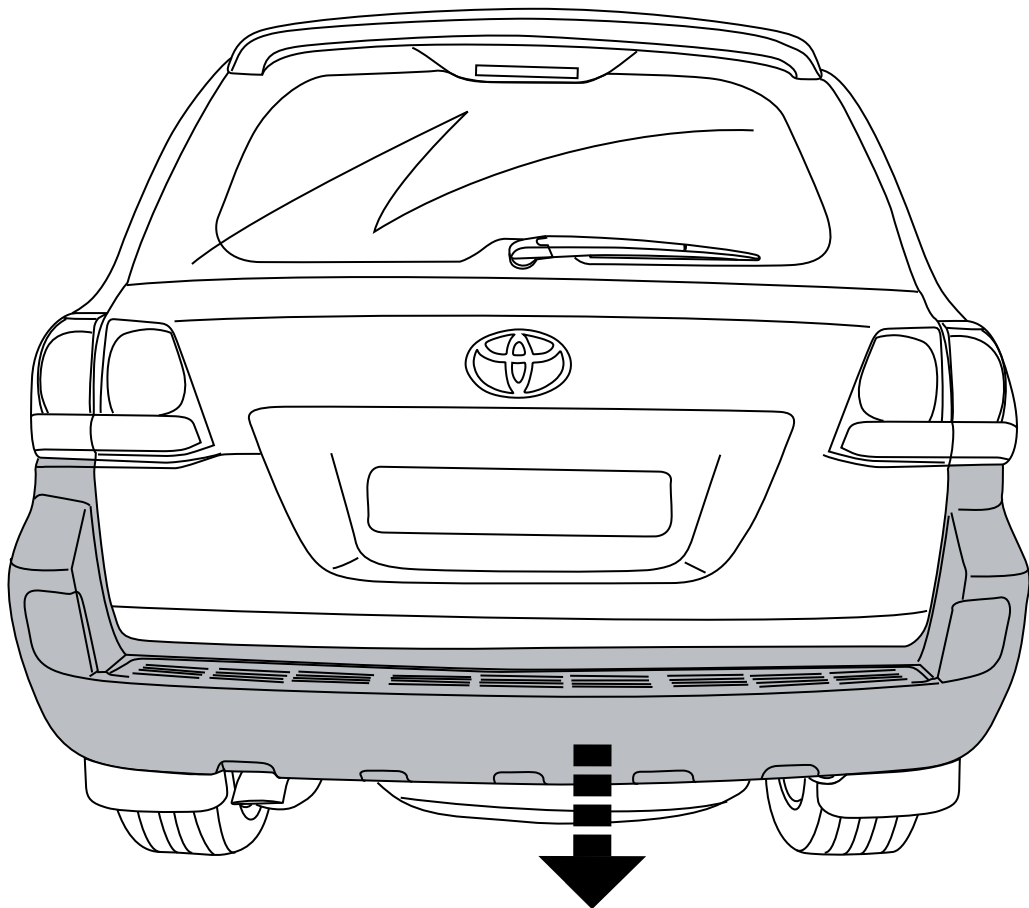

8

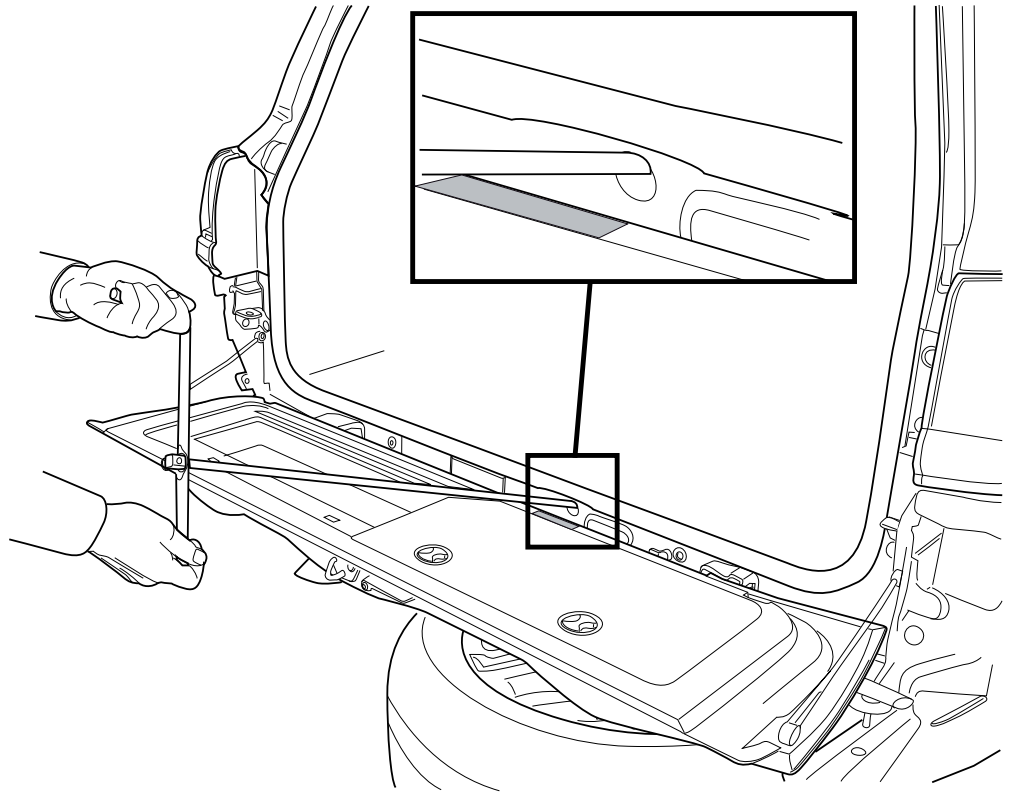
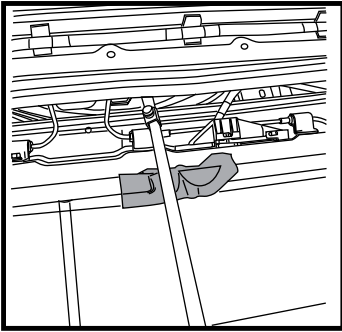
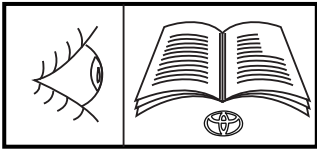
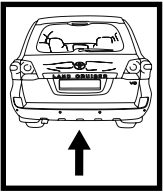

9

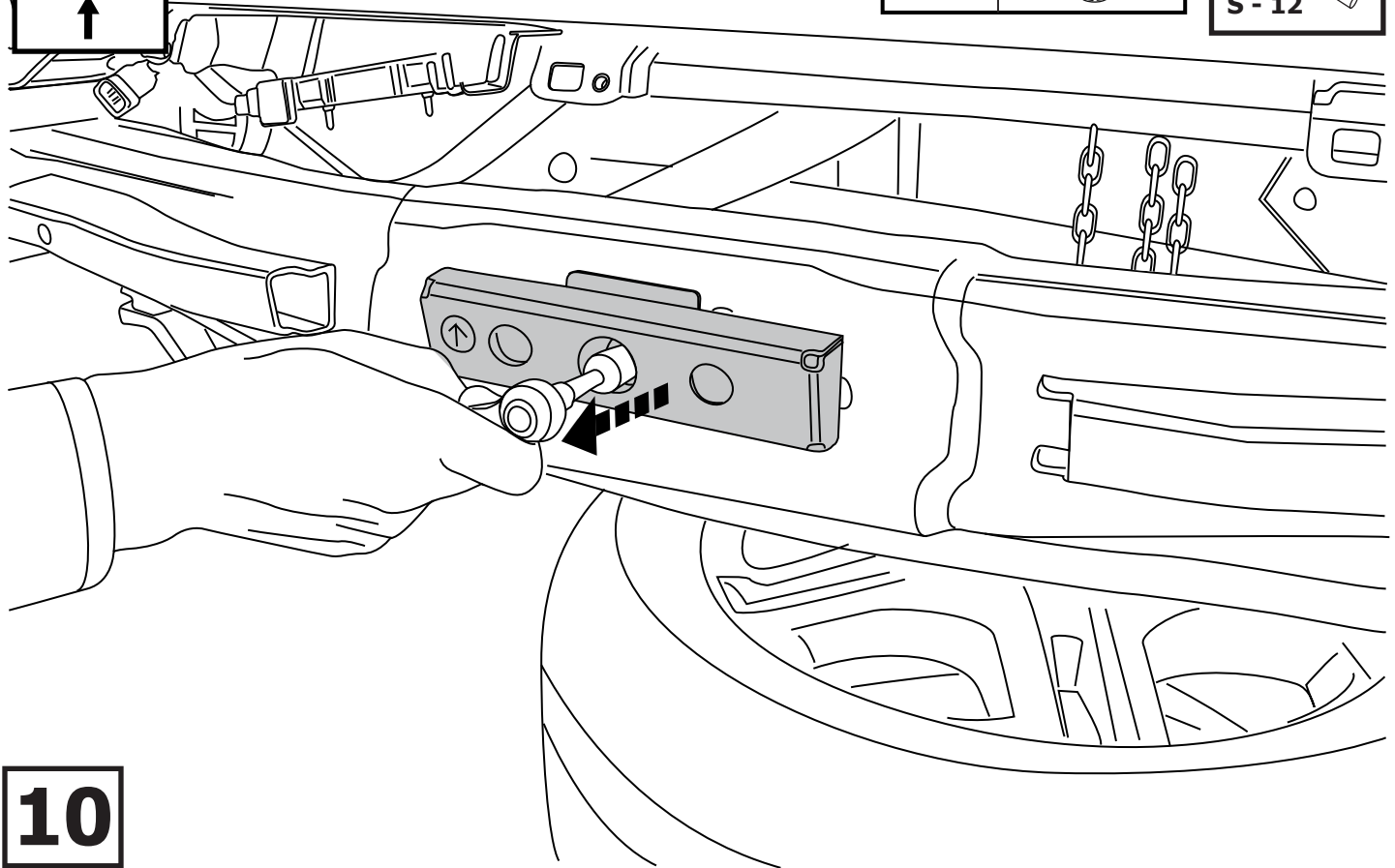
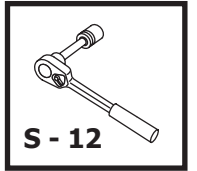
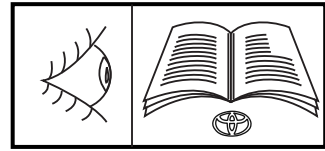
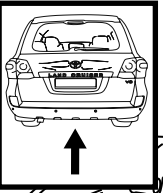

10

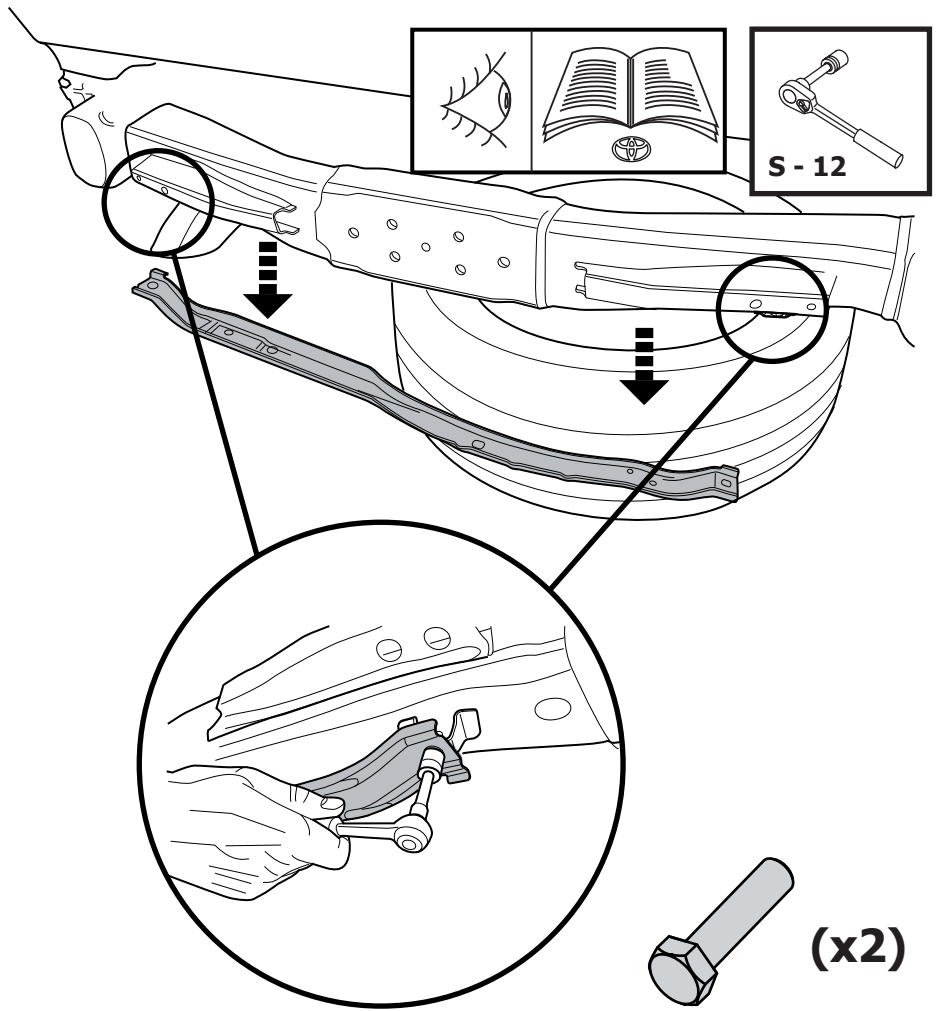
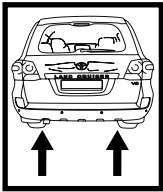

11

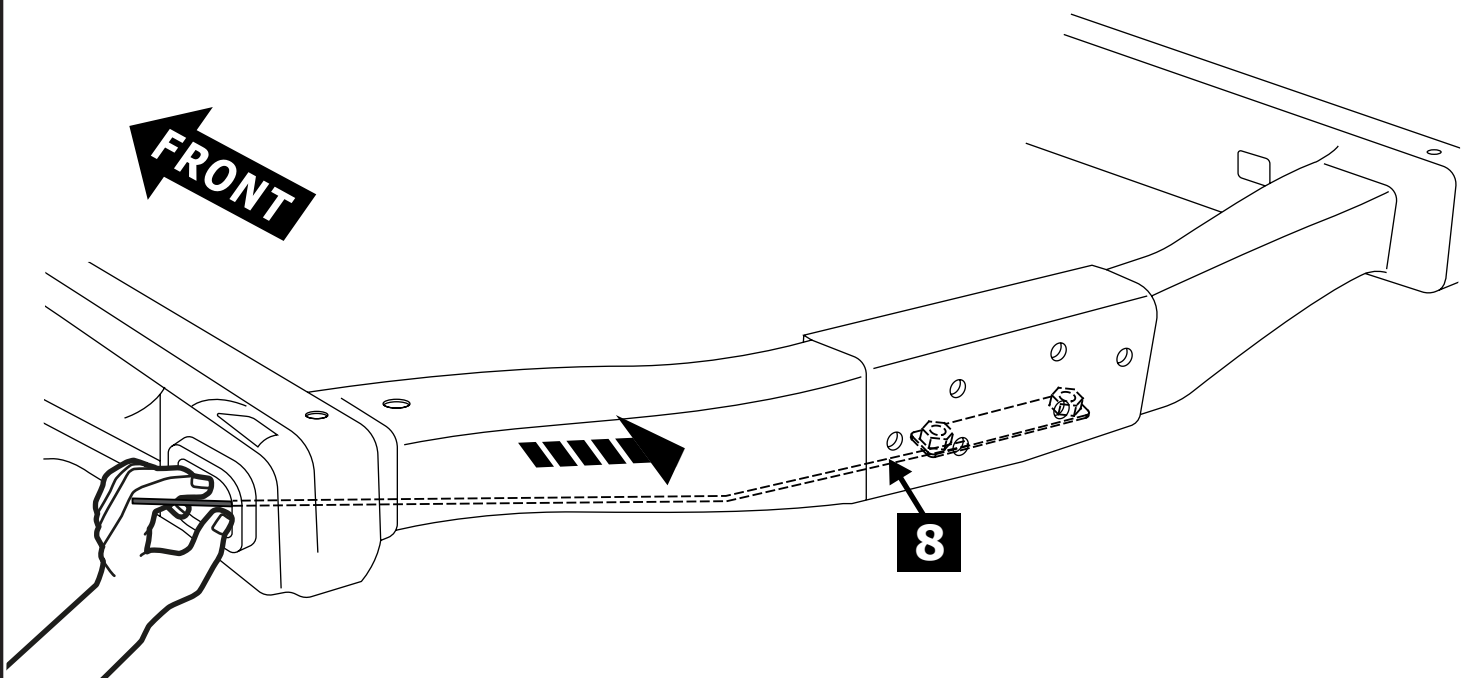

12

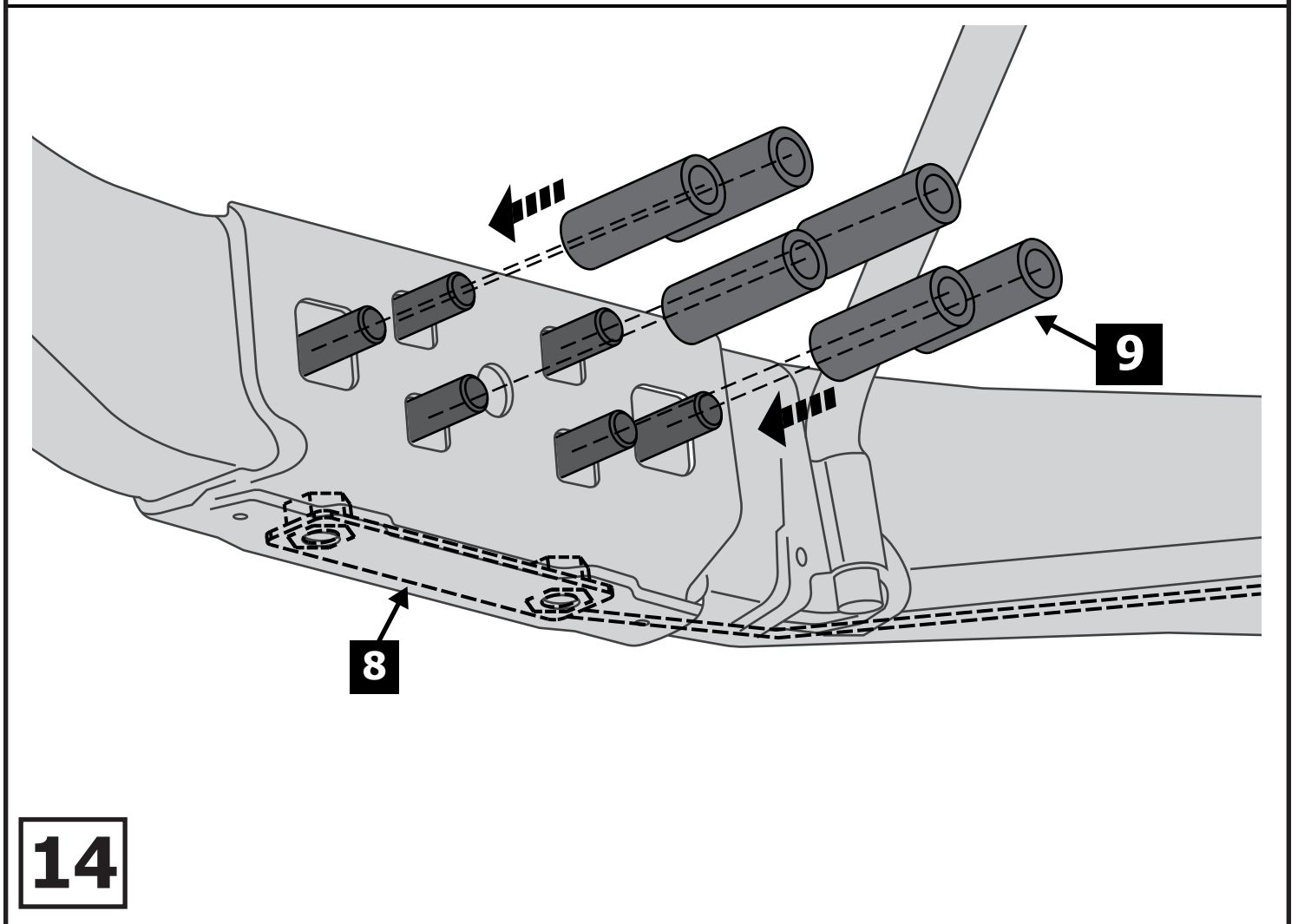
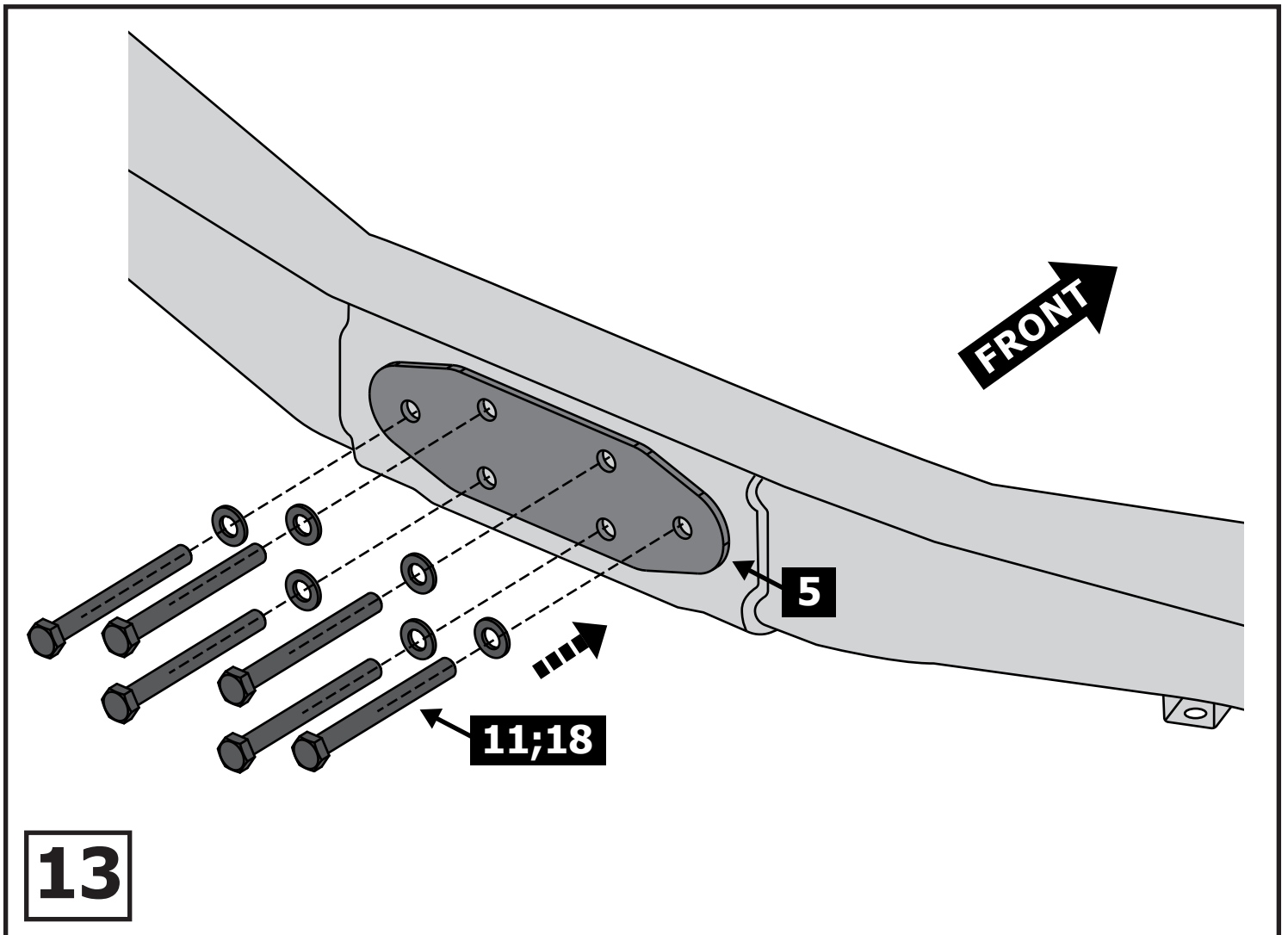

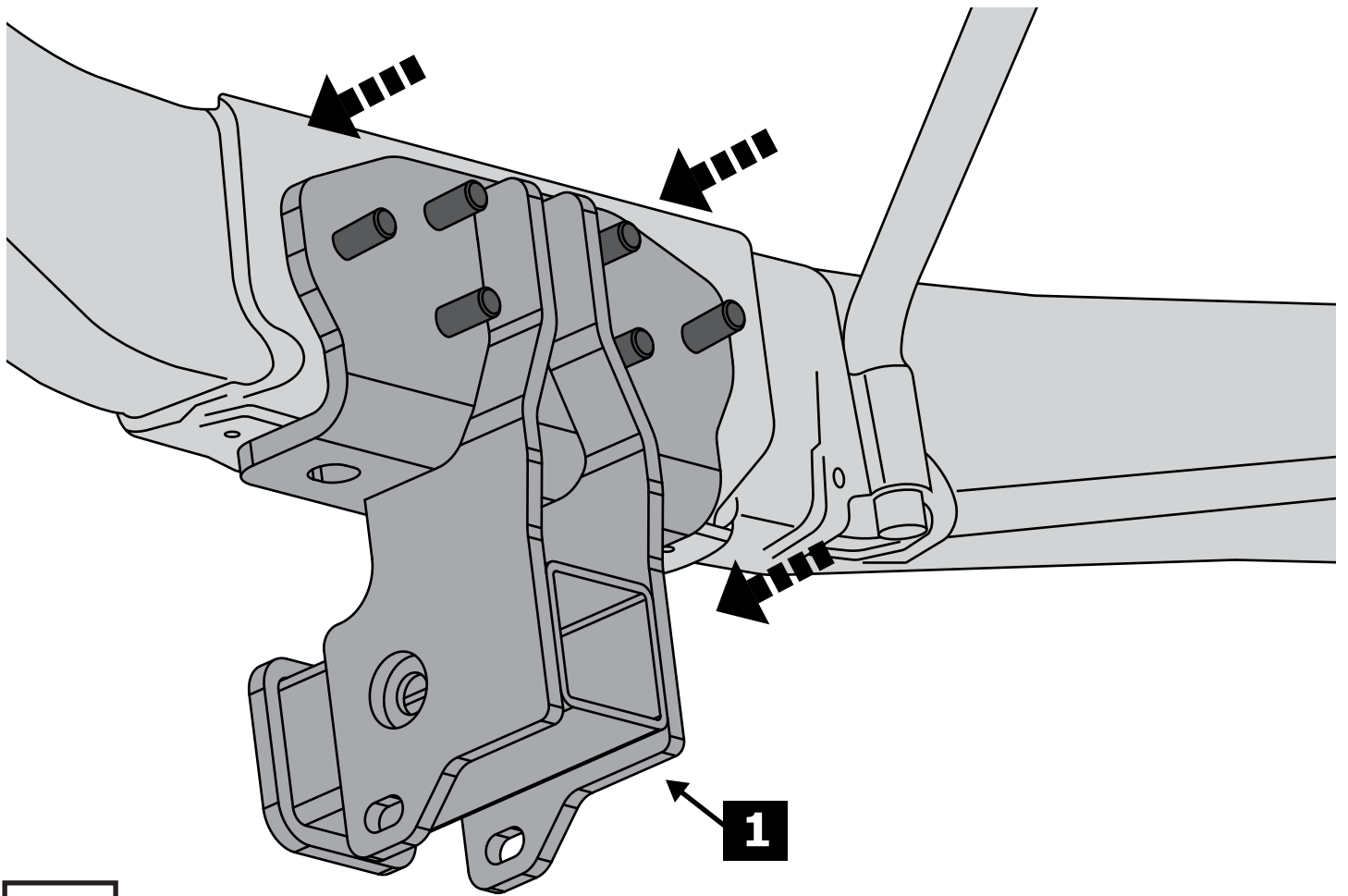

15

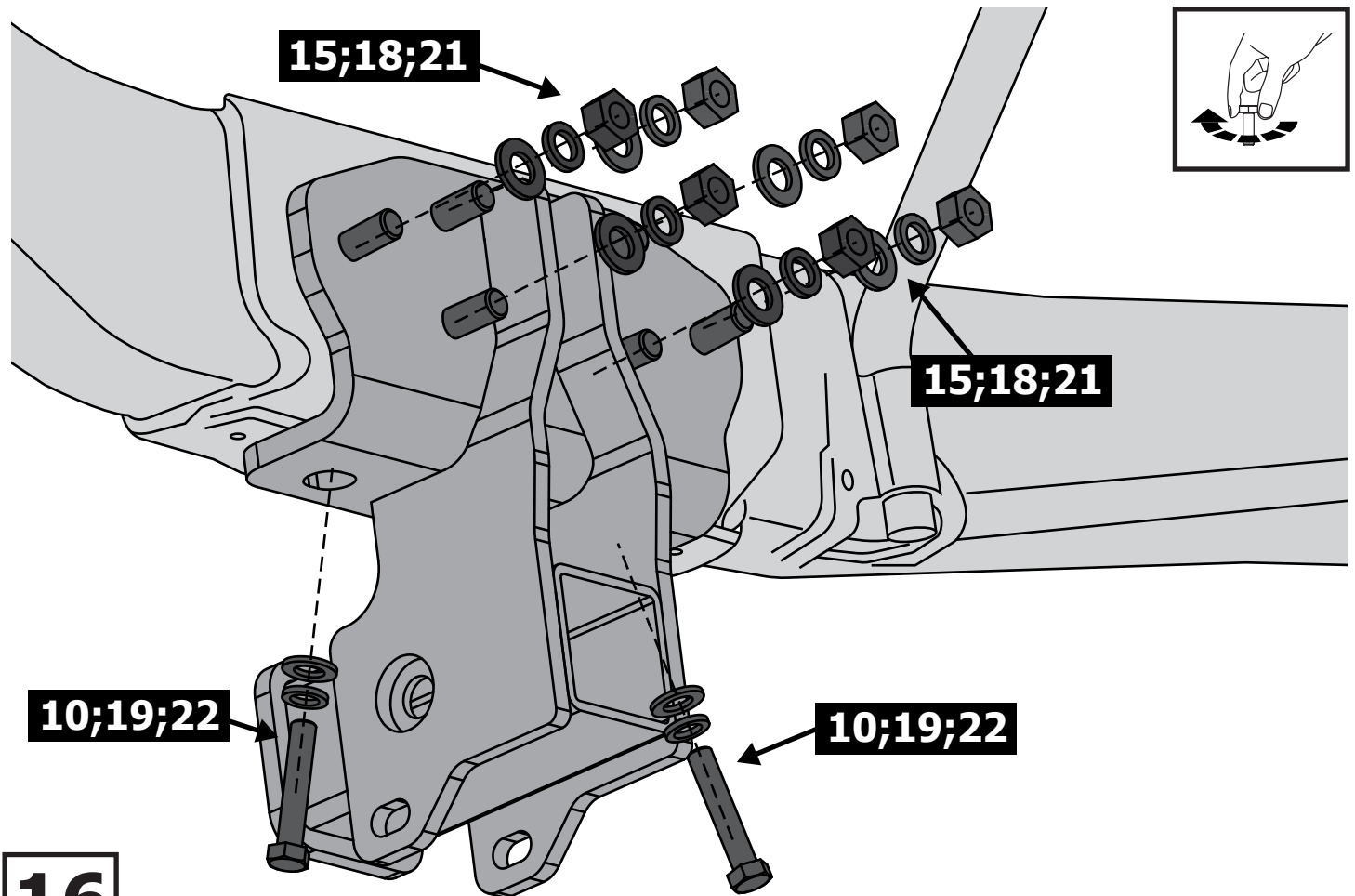

16

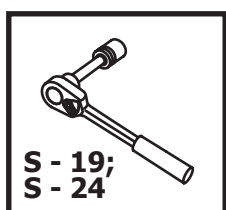
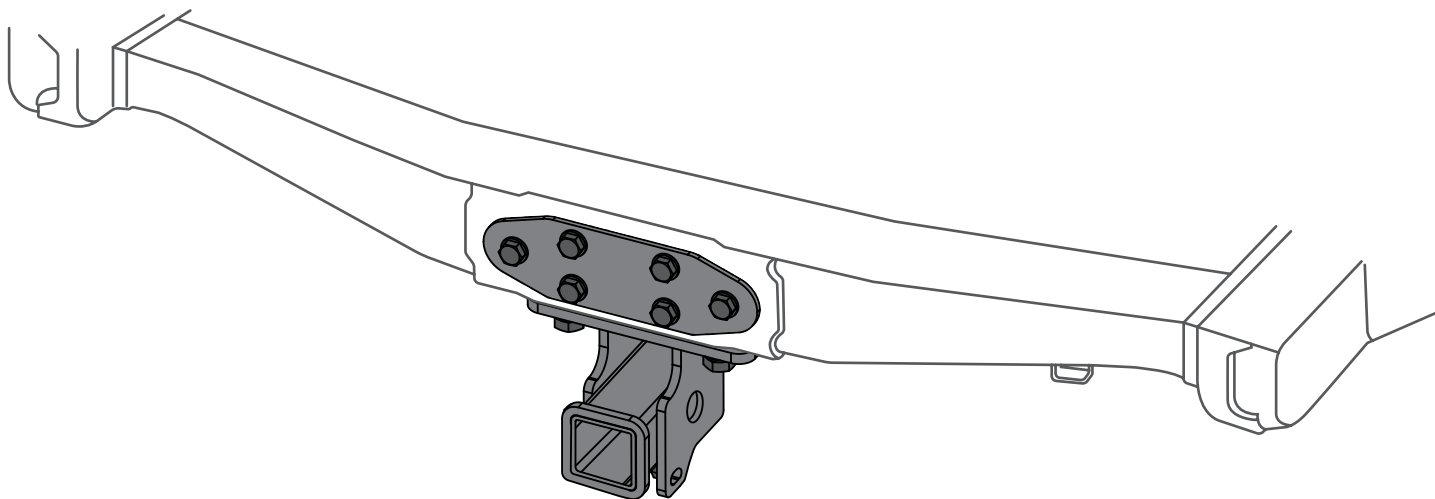

**Затянуть все резьбовые соединения
в указанном порядке:**

- 1. M16 = 157 Nm**
- 2. M12 = 81 Nm**

17

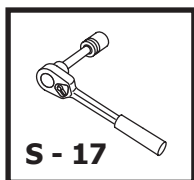

M10 = 50 Nm

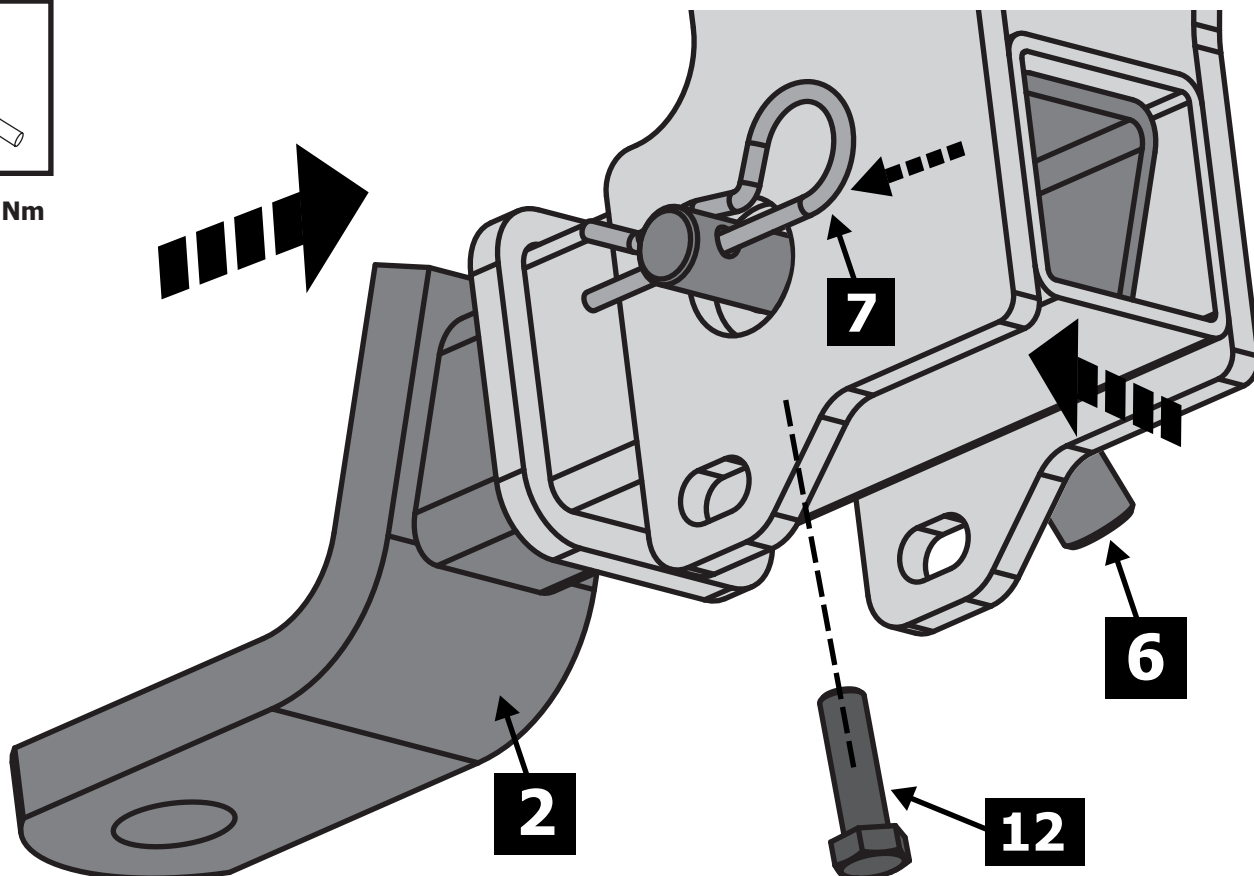

18

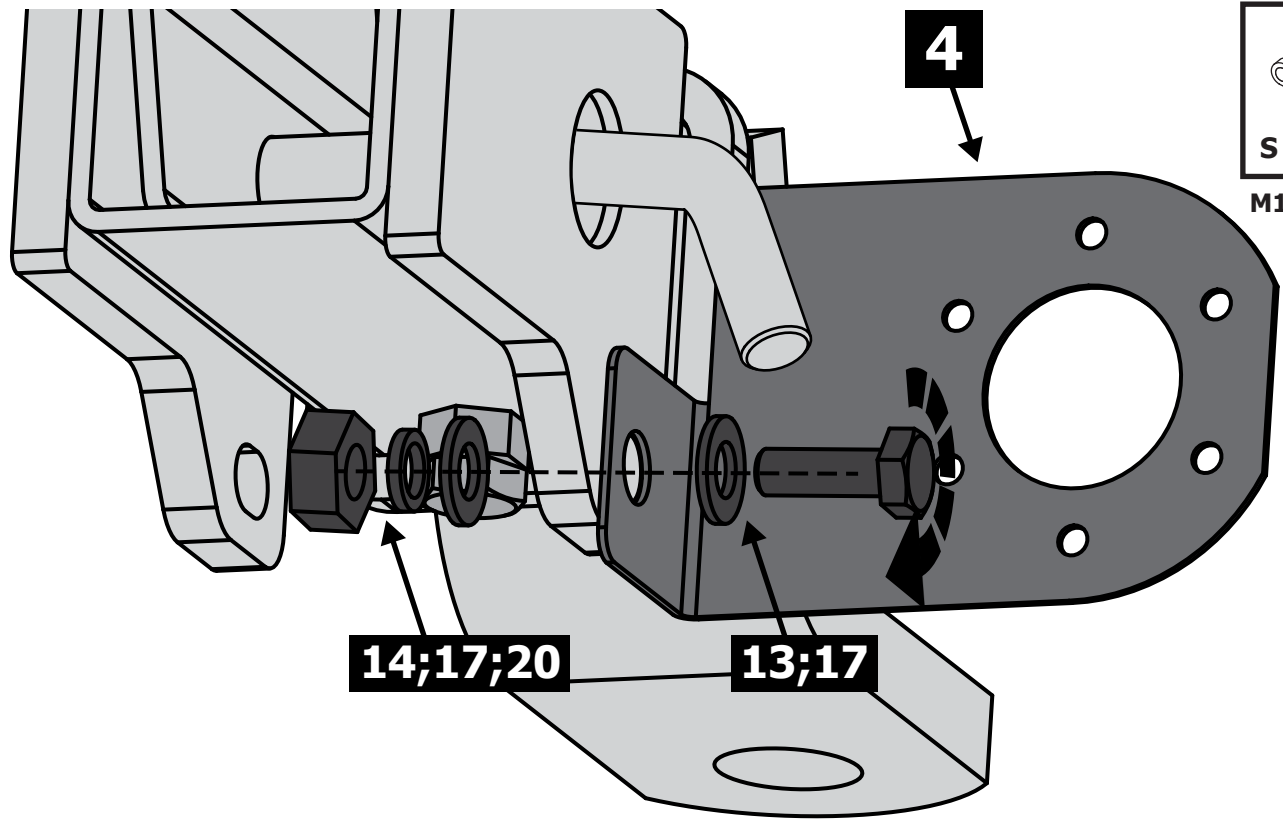

19

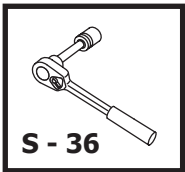

$M24 = 95 \text{ Nm}$

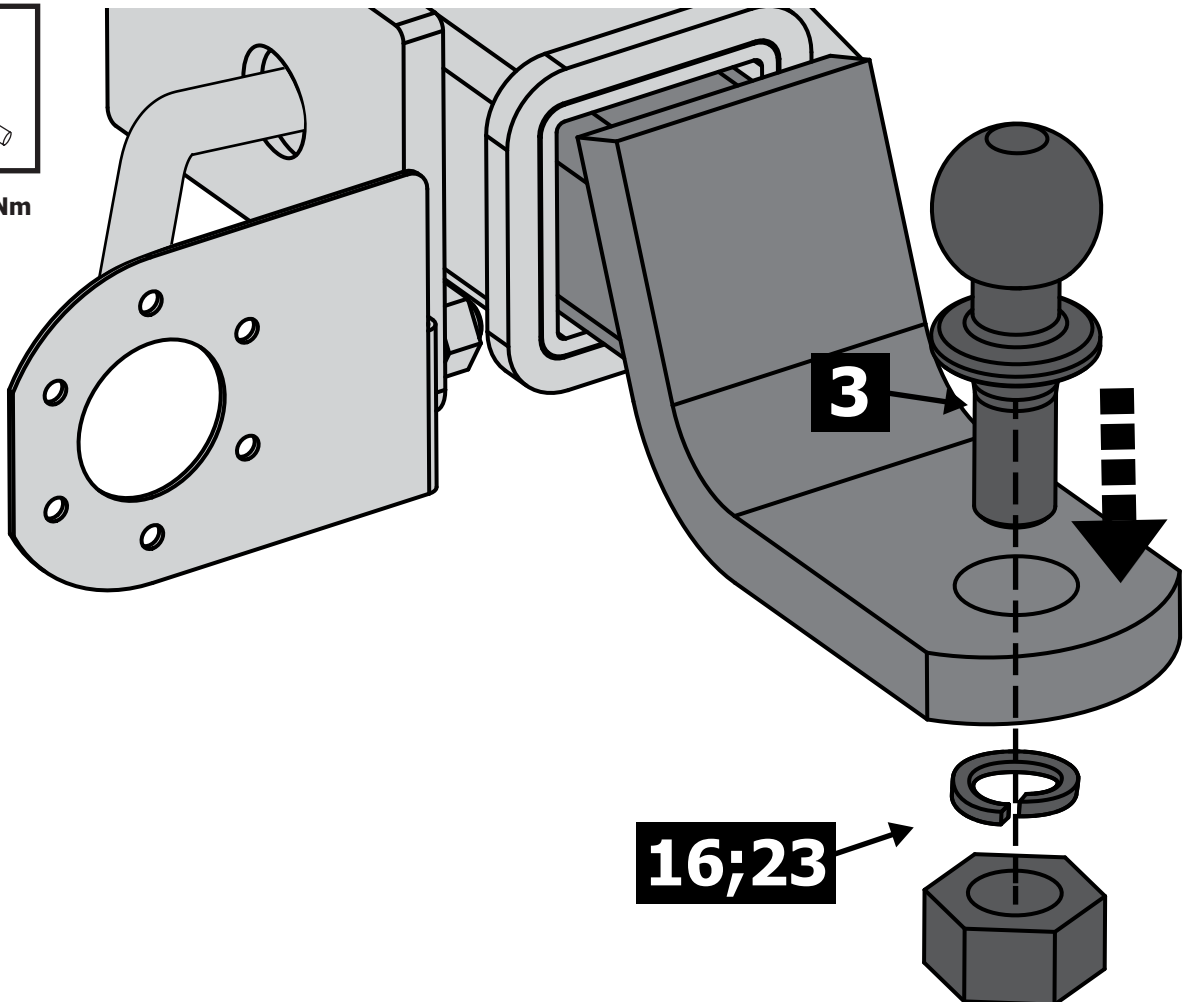

20

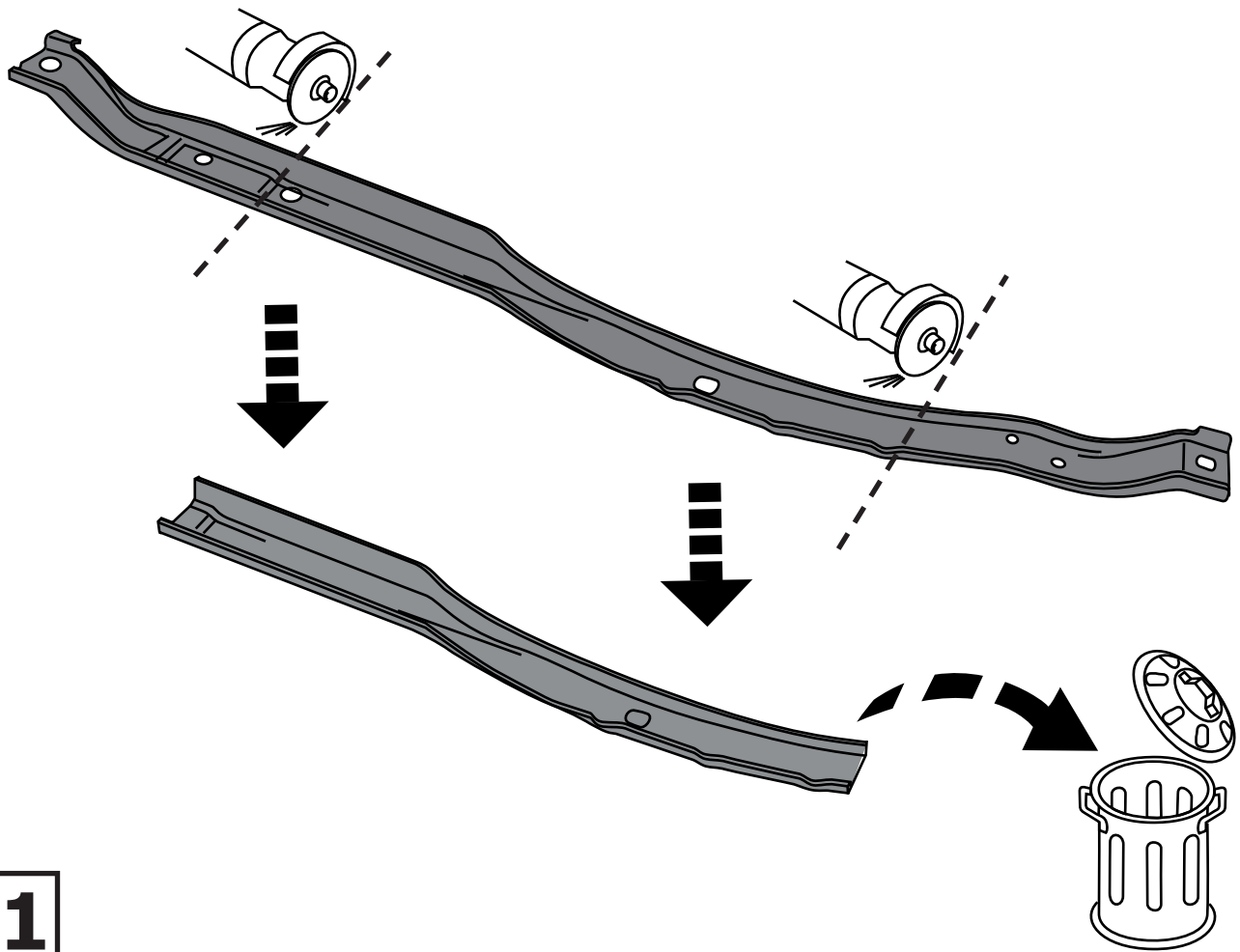

21

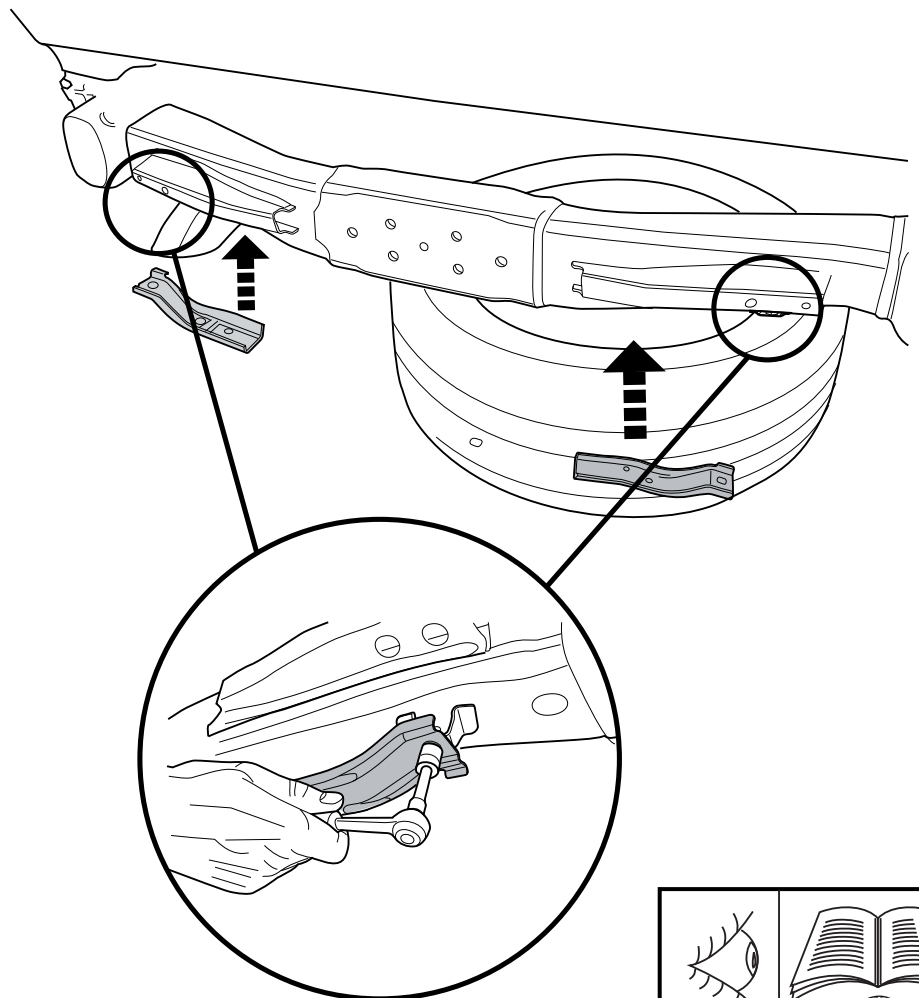
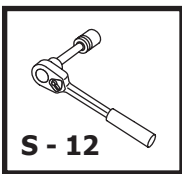
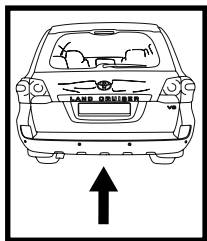

22

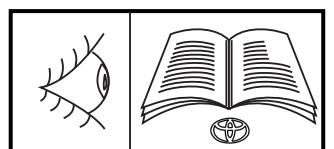

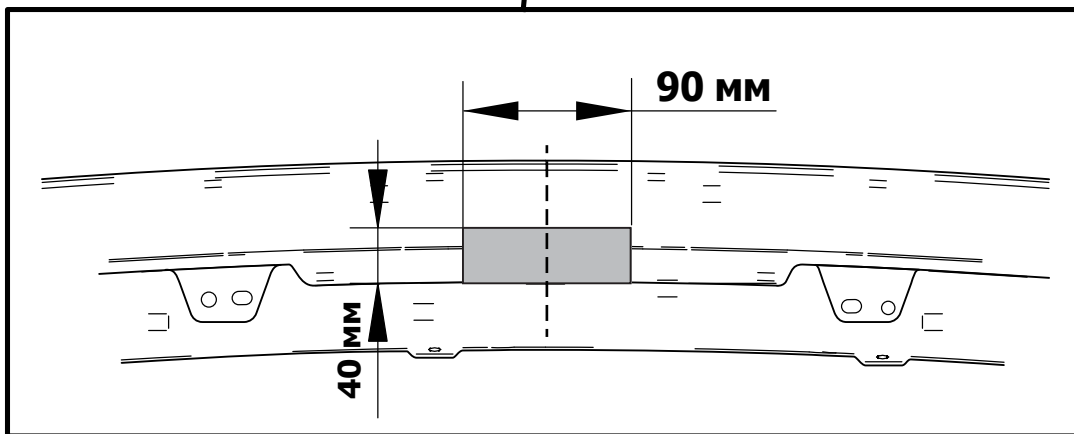
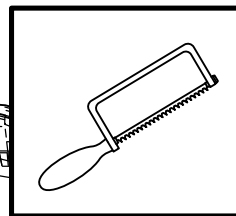
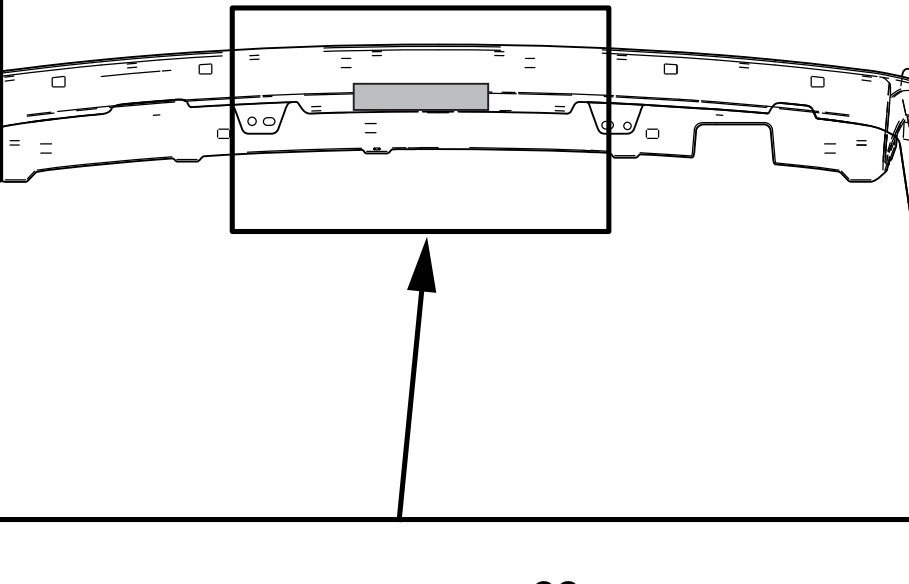
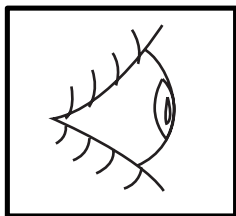

23

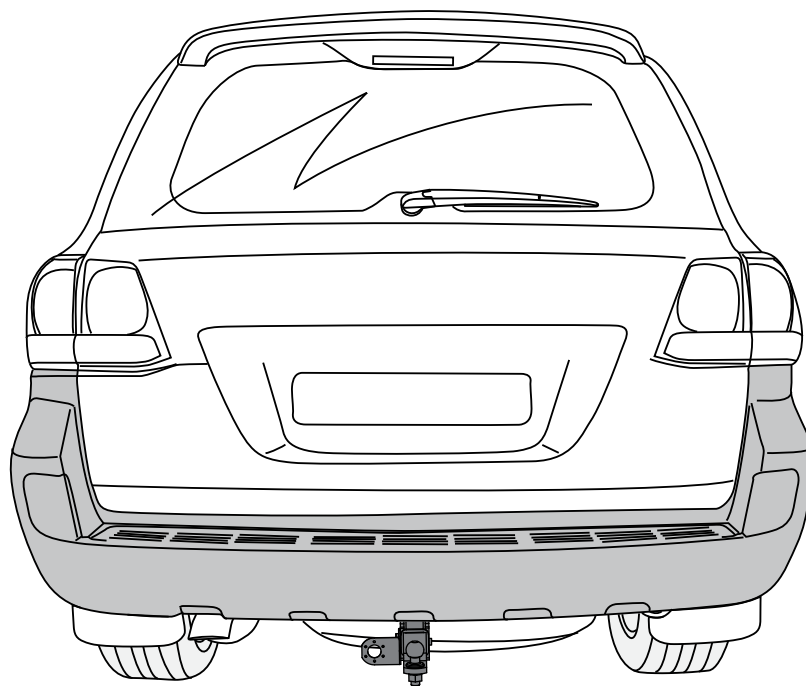
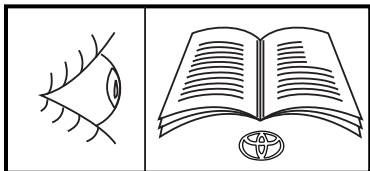

Установить бампер в последовательности
обратной снятию (стр. 2 - 9)

24