

Инструкция по установке

Renault Sandero

(2014-)

Renault Sandero Stepway

(2014-)

Renault Logan





(2014-)

Renault Logan Stepway

(2018-)

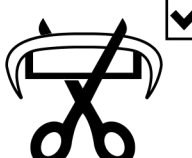

Арт.: F.4712.001

 <p>1000 kg</p>	 <p>75 kg</p>	$D \text{ (kN)} = \frac{\text{MAX kg} \times \text{MAX kg}}{\text{MAX kg} + \text{MAX kg}} \times 0,00981$  
<p>D = 6.05 kN</p>		

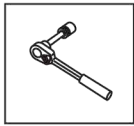

Вкрутить/выкрутить используя инструмент

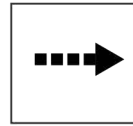

Движение

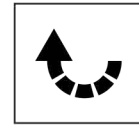

Поворот



Вкрутить/выкрутить не затягивая

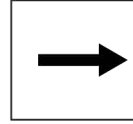

Расположение

Используемый инструмент:

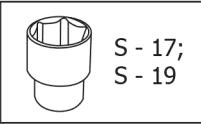
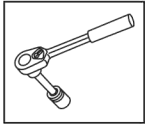







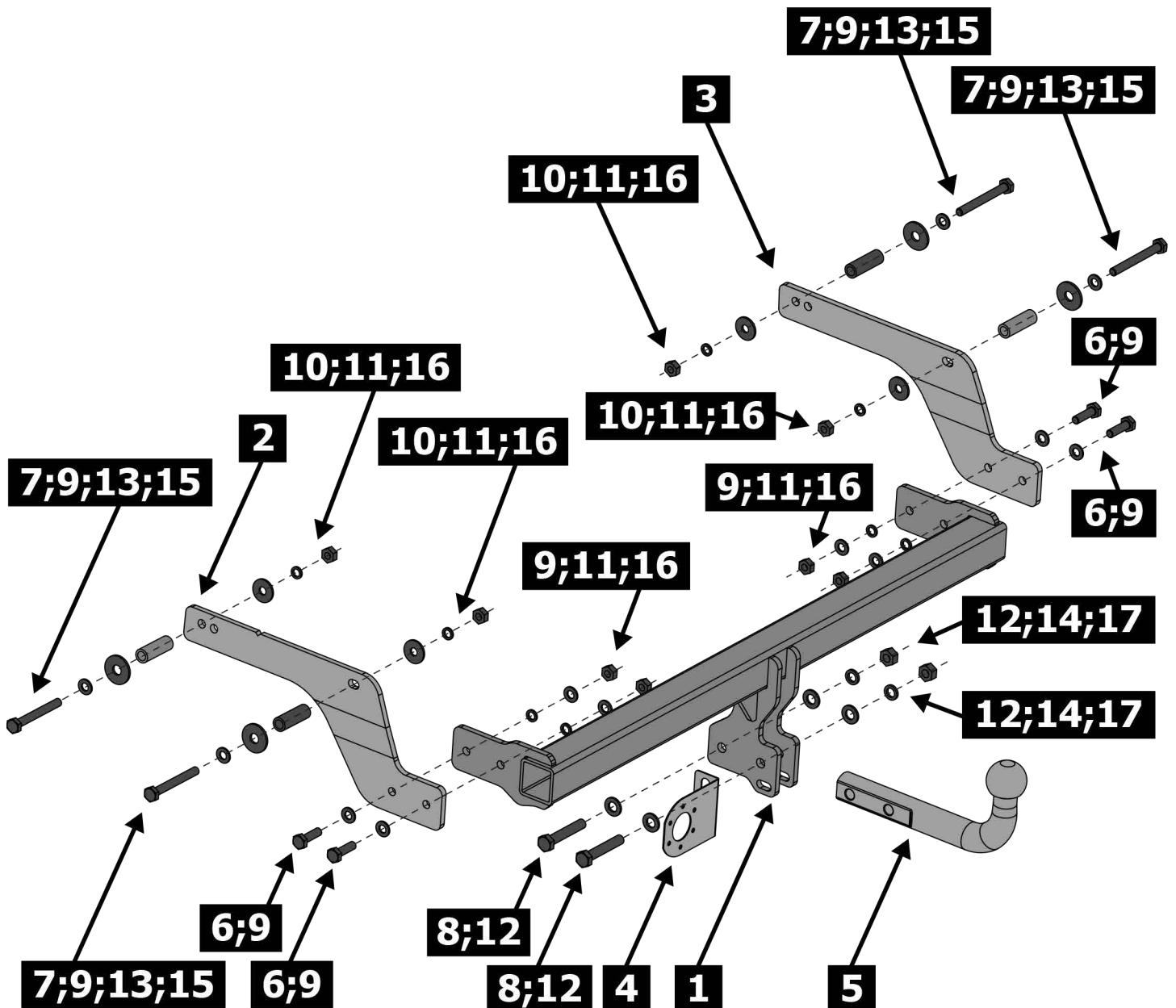

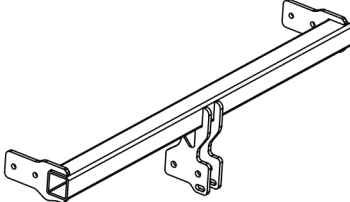
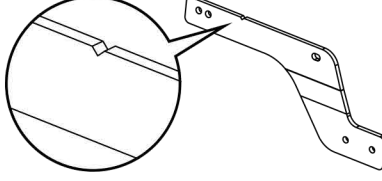
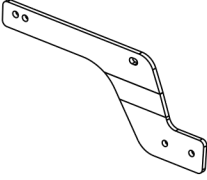

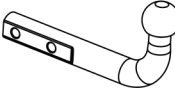



S - 17;
S - 19



Office Knife

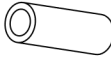

1	x1	Балка	
2	x1	Кронштейн левый	
3	x1	Кронштейн правый	
4	x1	Подрозетник	
5	x1	Крюк	
6	x4	M10x35	
7	x4	M10x90	
8	x2	M12x1.25x70	
9	x12	Ø 10	
10	x4	Ø 10	
11	x8	Ø 10	
12	x4	Ø 12	
13	x4	Ø 12	
14	x2	Ø 12	
15	x4	Втулка 53 мм	
16	x8	M10	
17	x2	M12x1.25	

Sandero

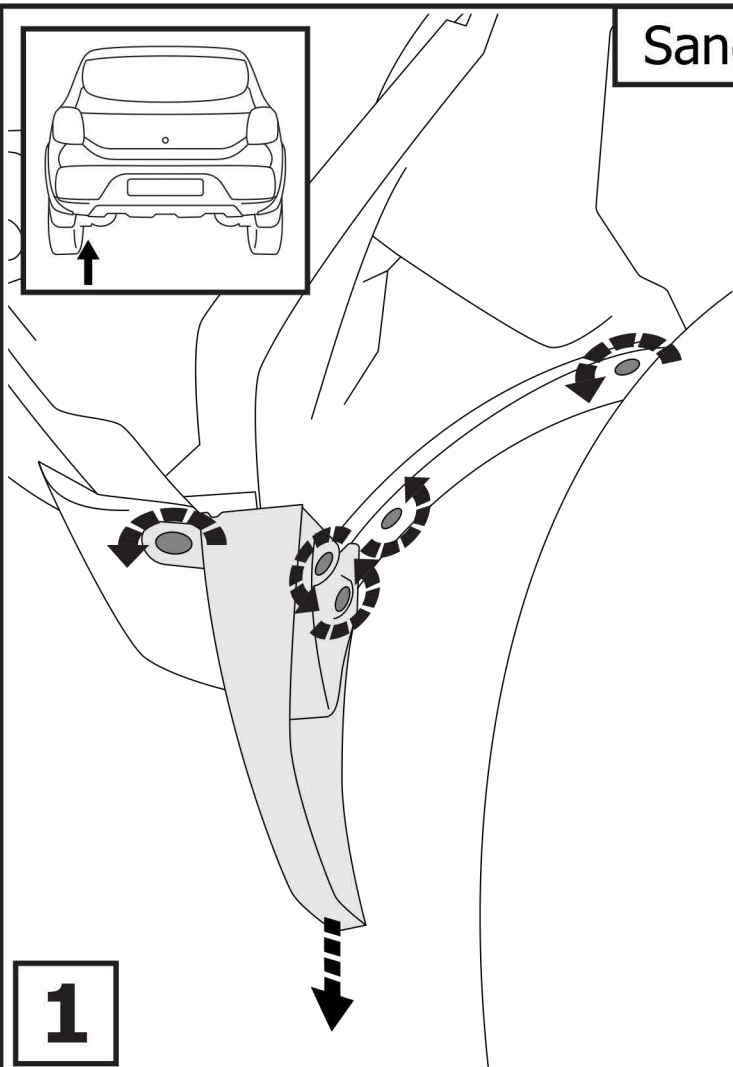
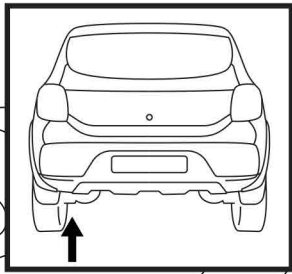

1

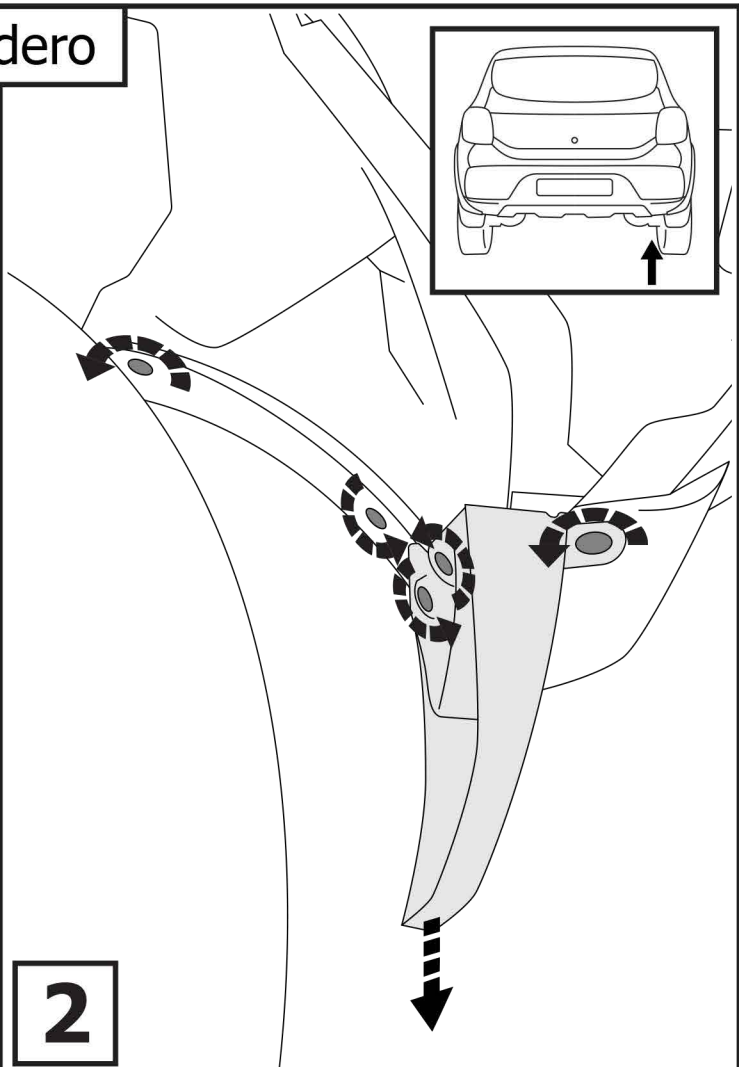
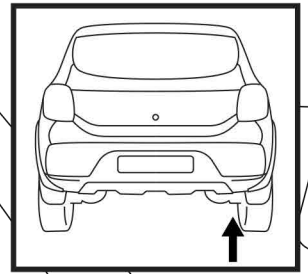

2

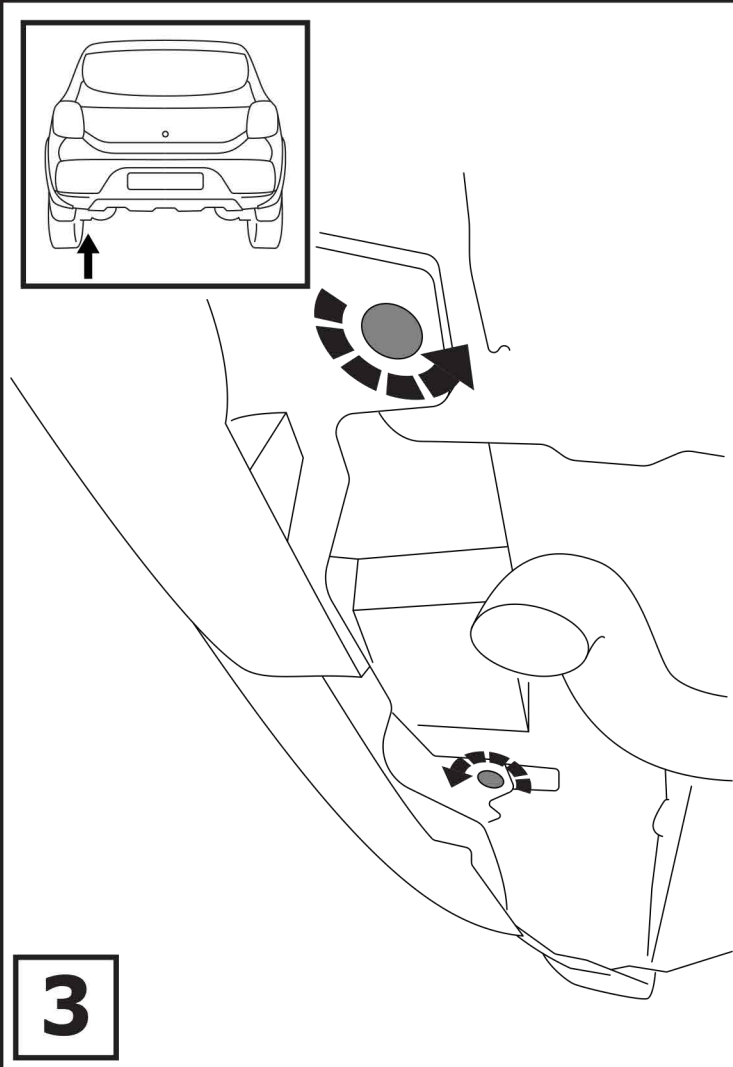
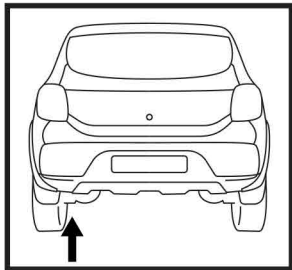

3

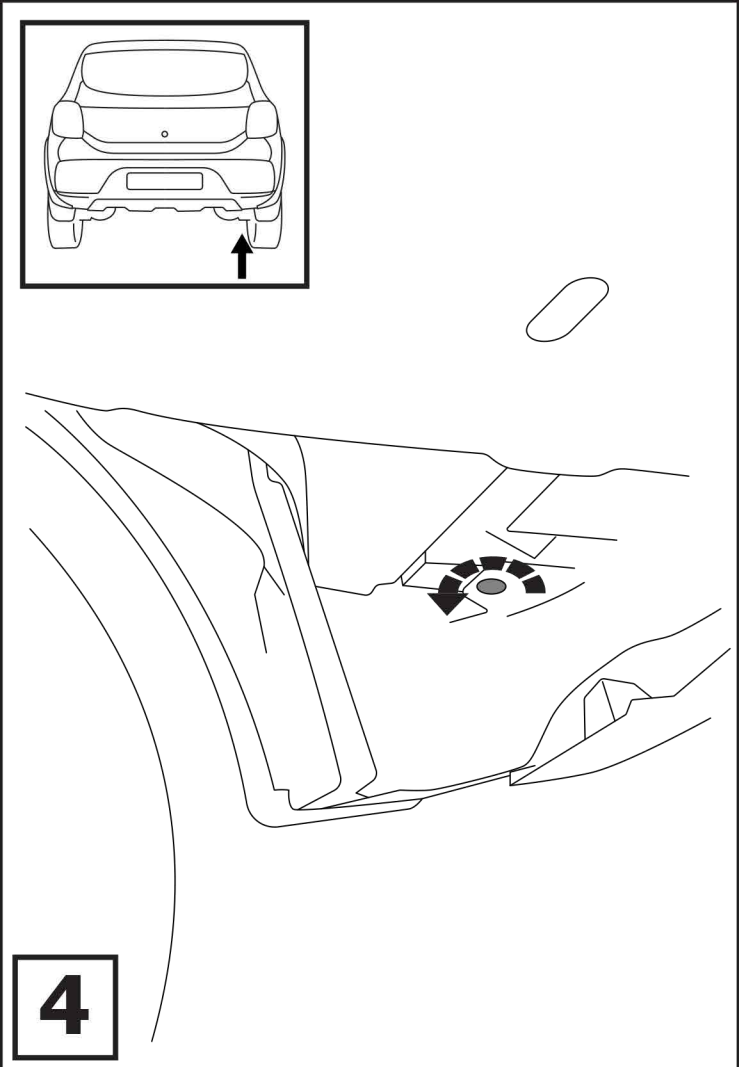
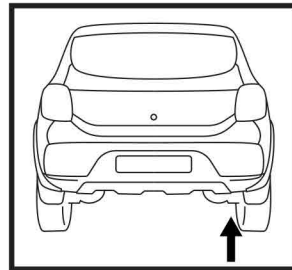

4

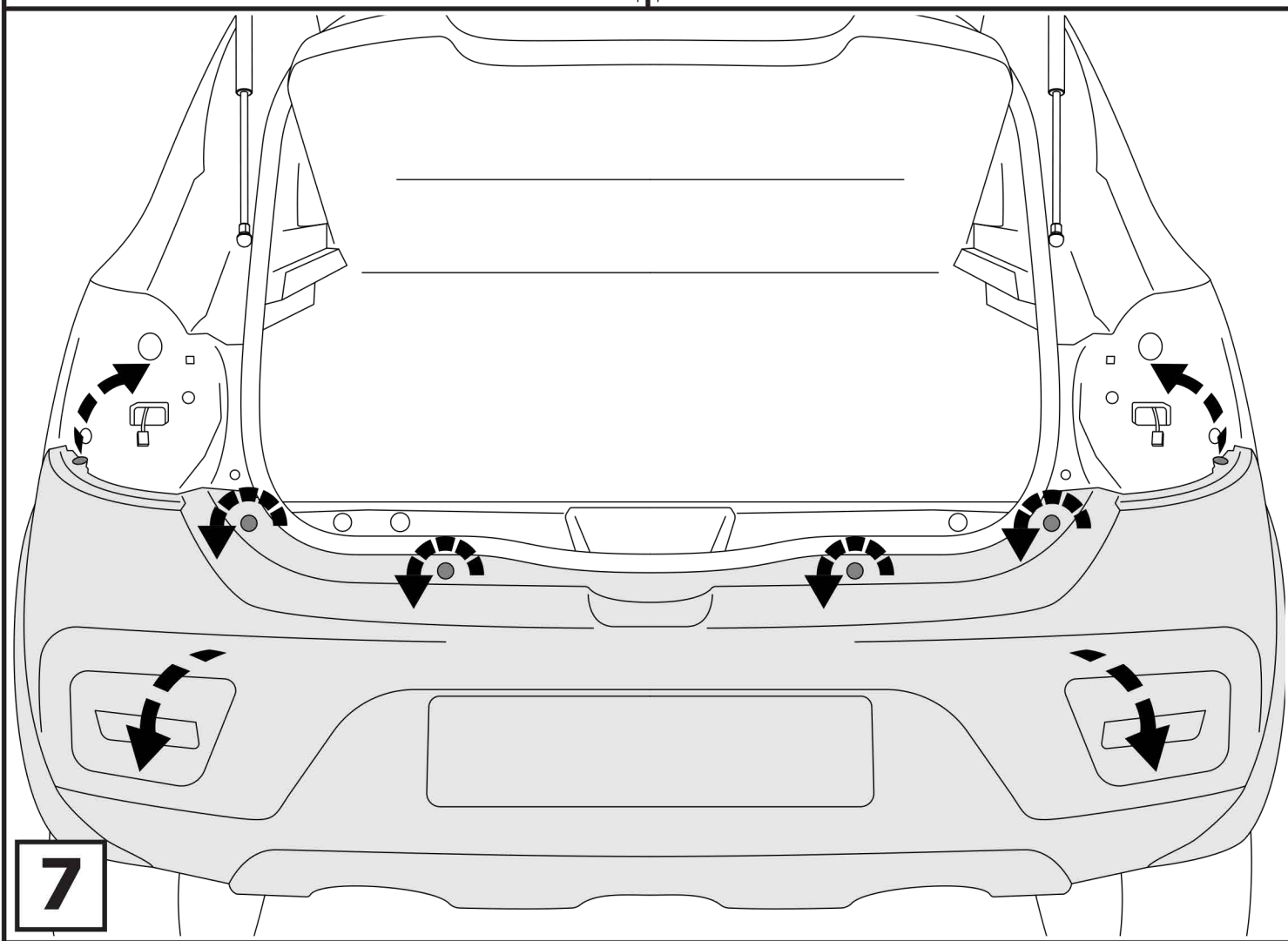
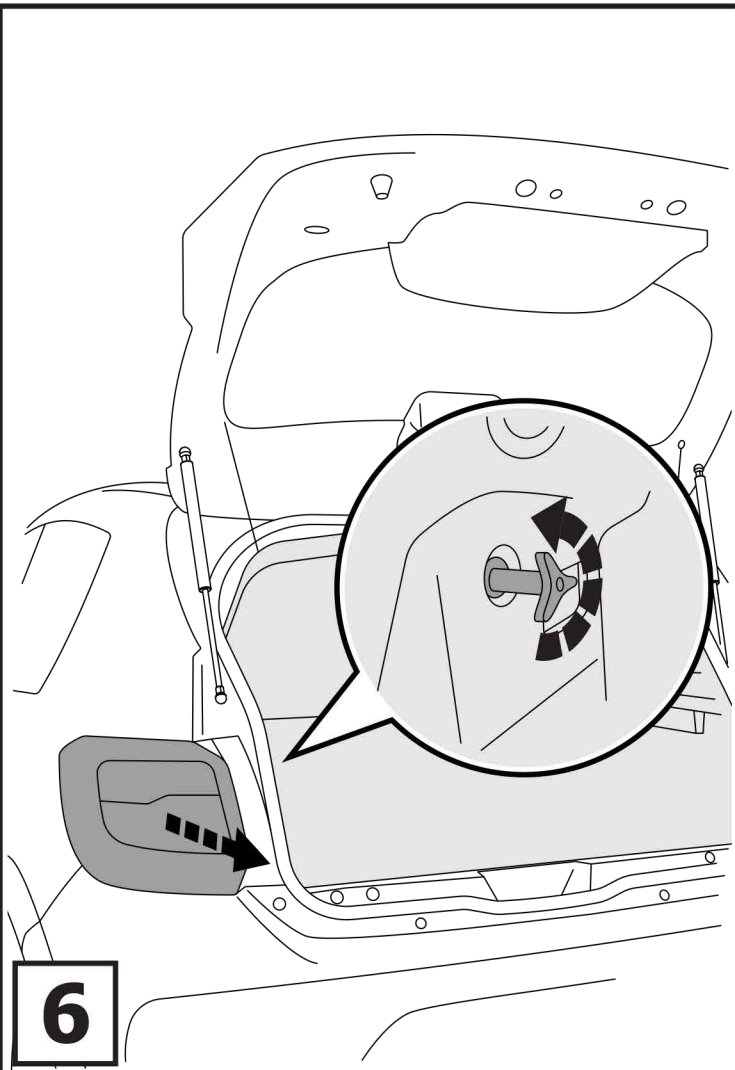
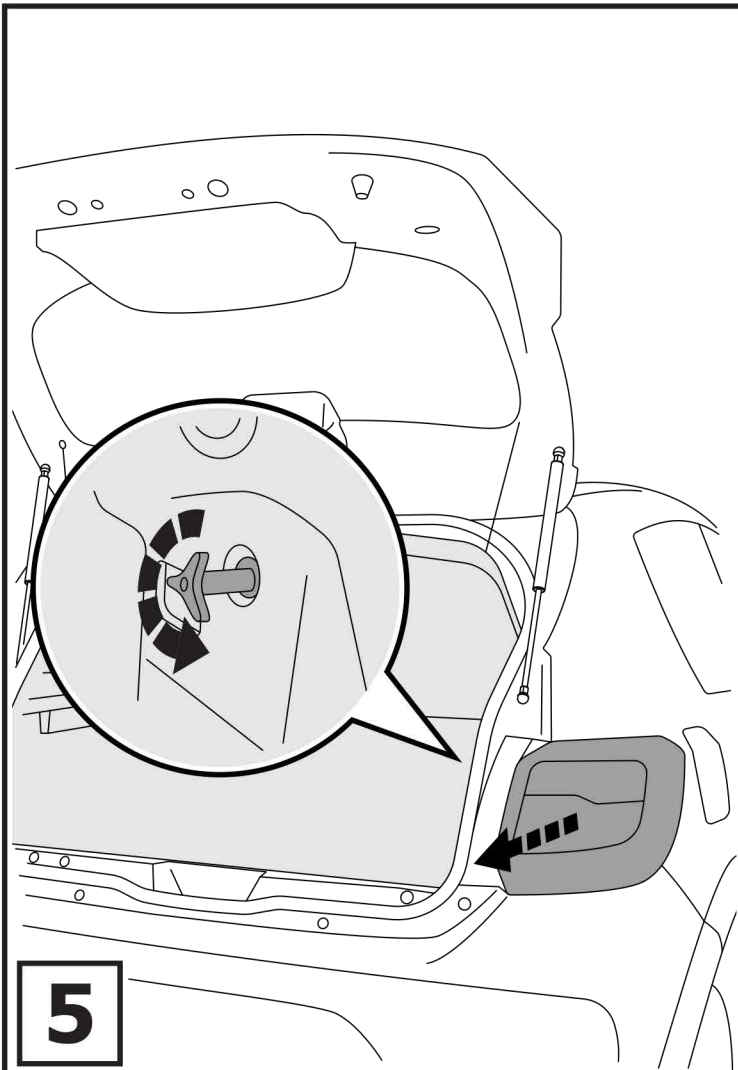

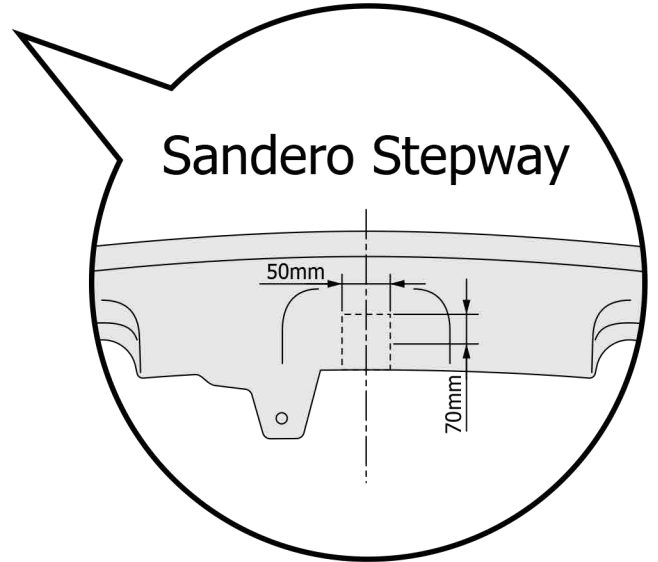
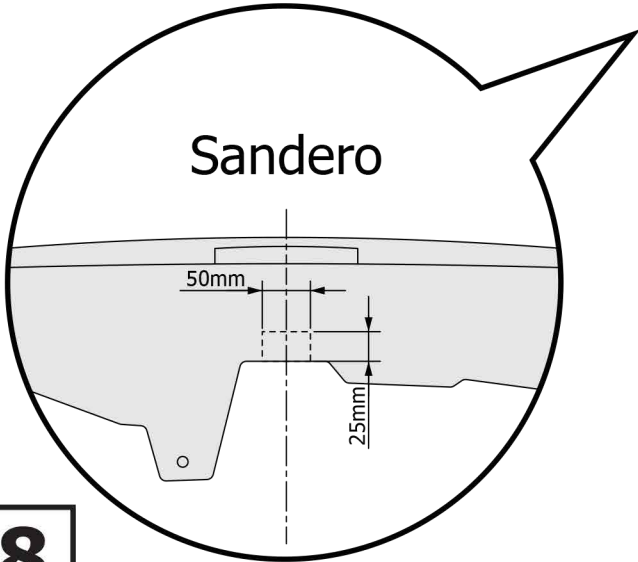
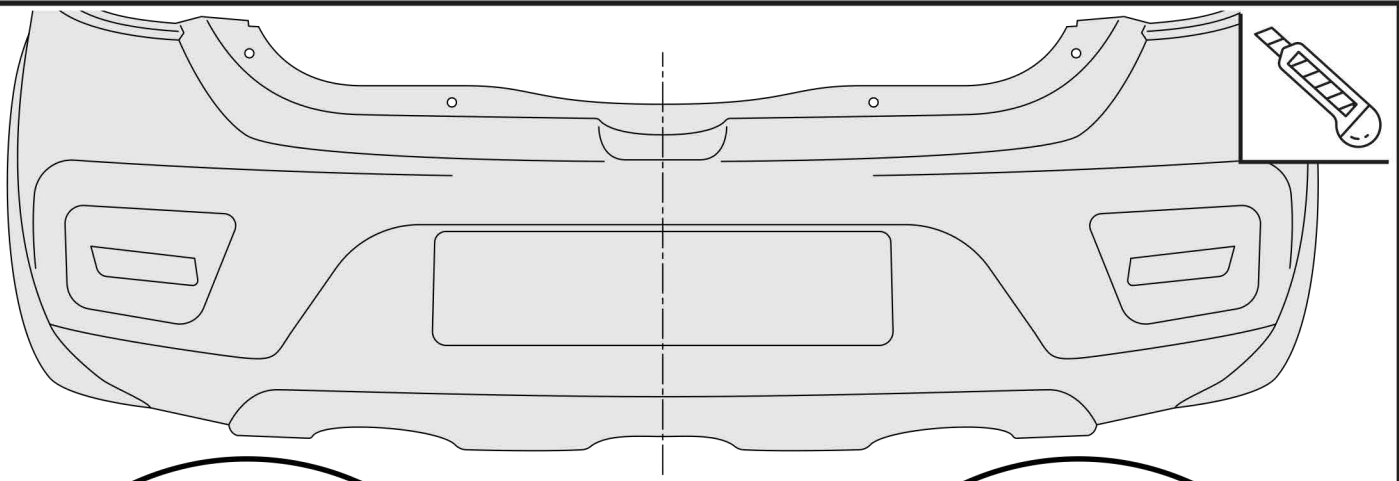

8

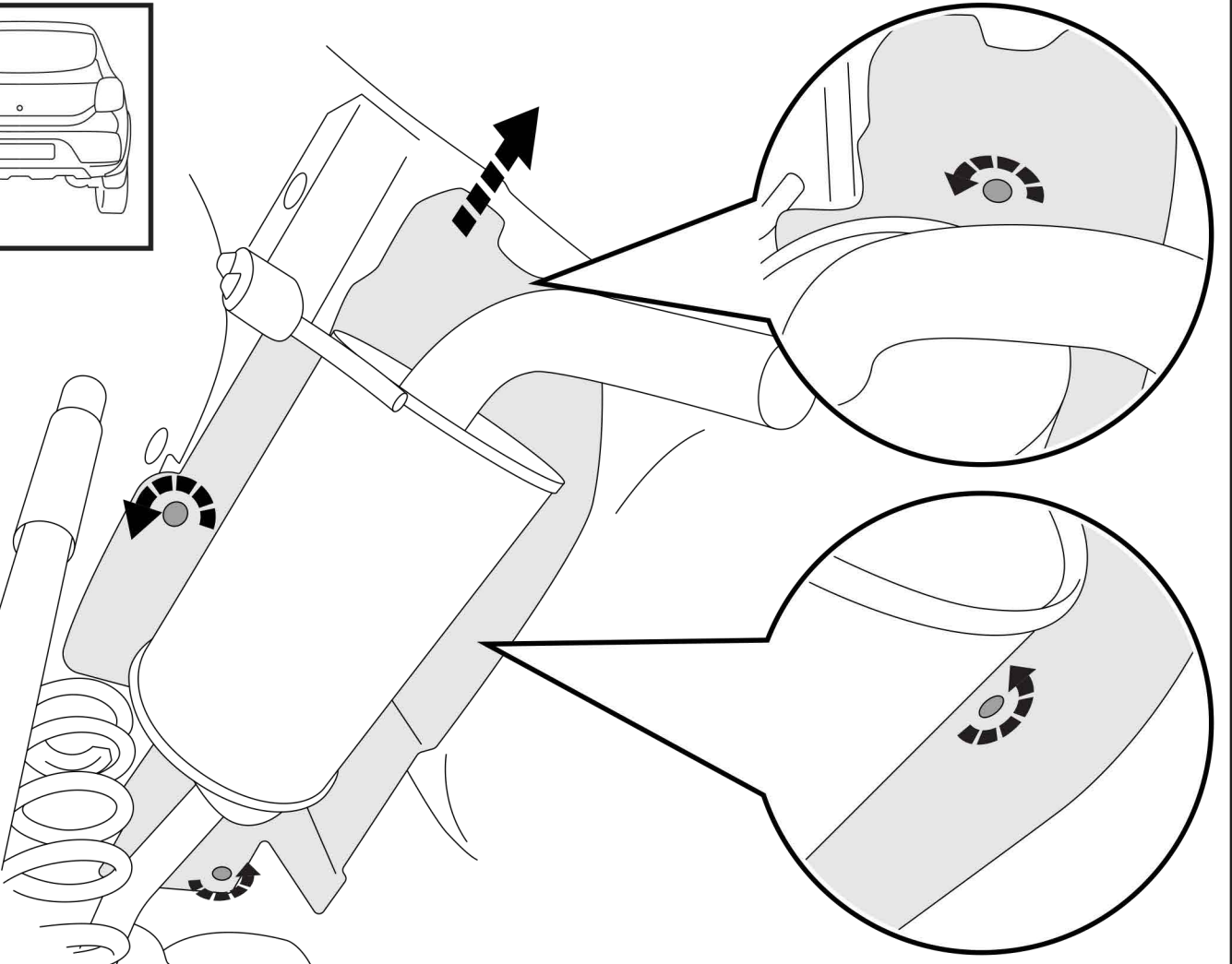
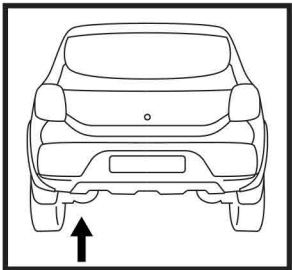

9

Sandero / Logan

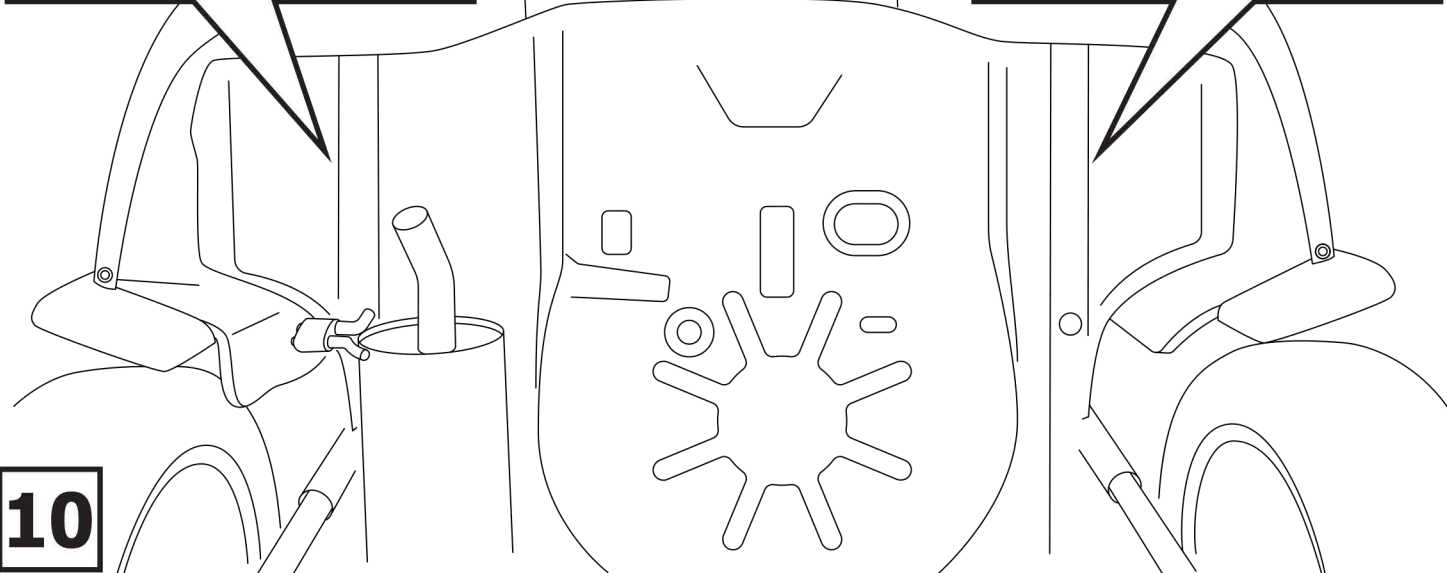
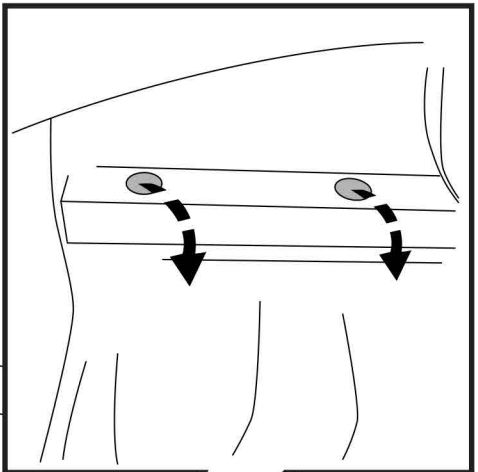
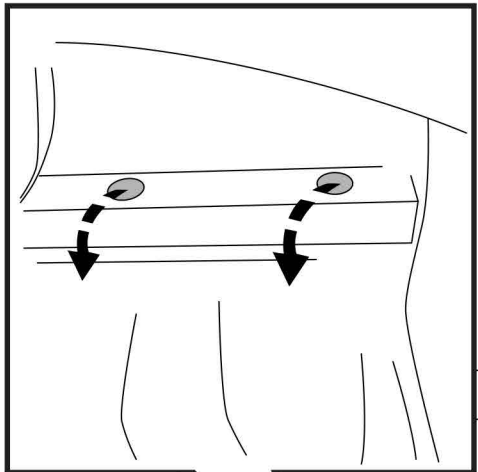

10

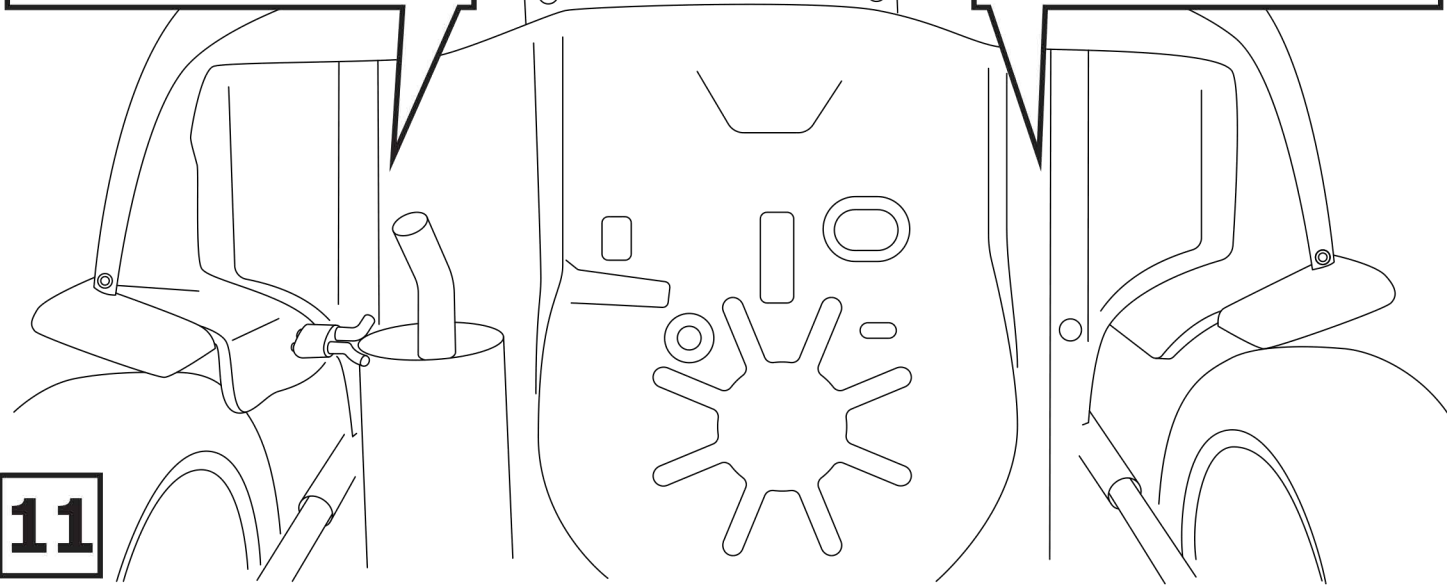
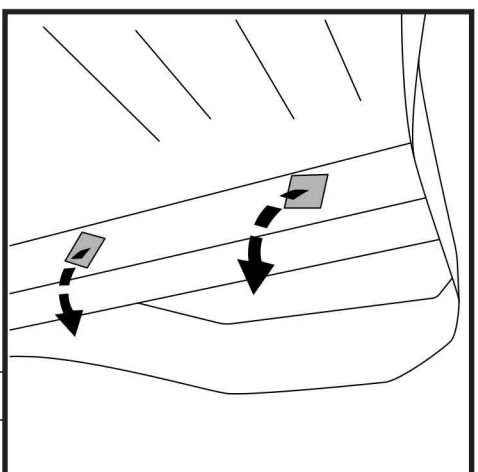
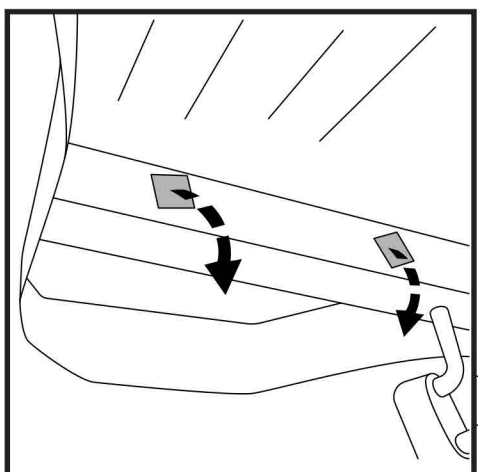

11

