



Инструкция по установке

Toyota Land Cruiser Prado 150

(2009-) кроме комплектации **Black Onyx**



Арт.: F.5714.006

 <p>2500 kg</p>	 <p>75 kg</p>	$D \text{ (kN)} = \frac{\text{MAX kg} \times \text{MAX kg}}{\text{MAX kg} + \text{MAX kg}} \times 0,00981$
<p>D = 13.1 kN</p>		



Вкрутить/выкрутить используя инструмент

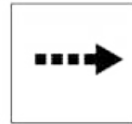

Движение



Поворот





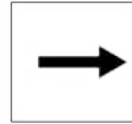





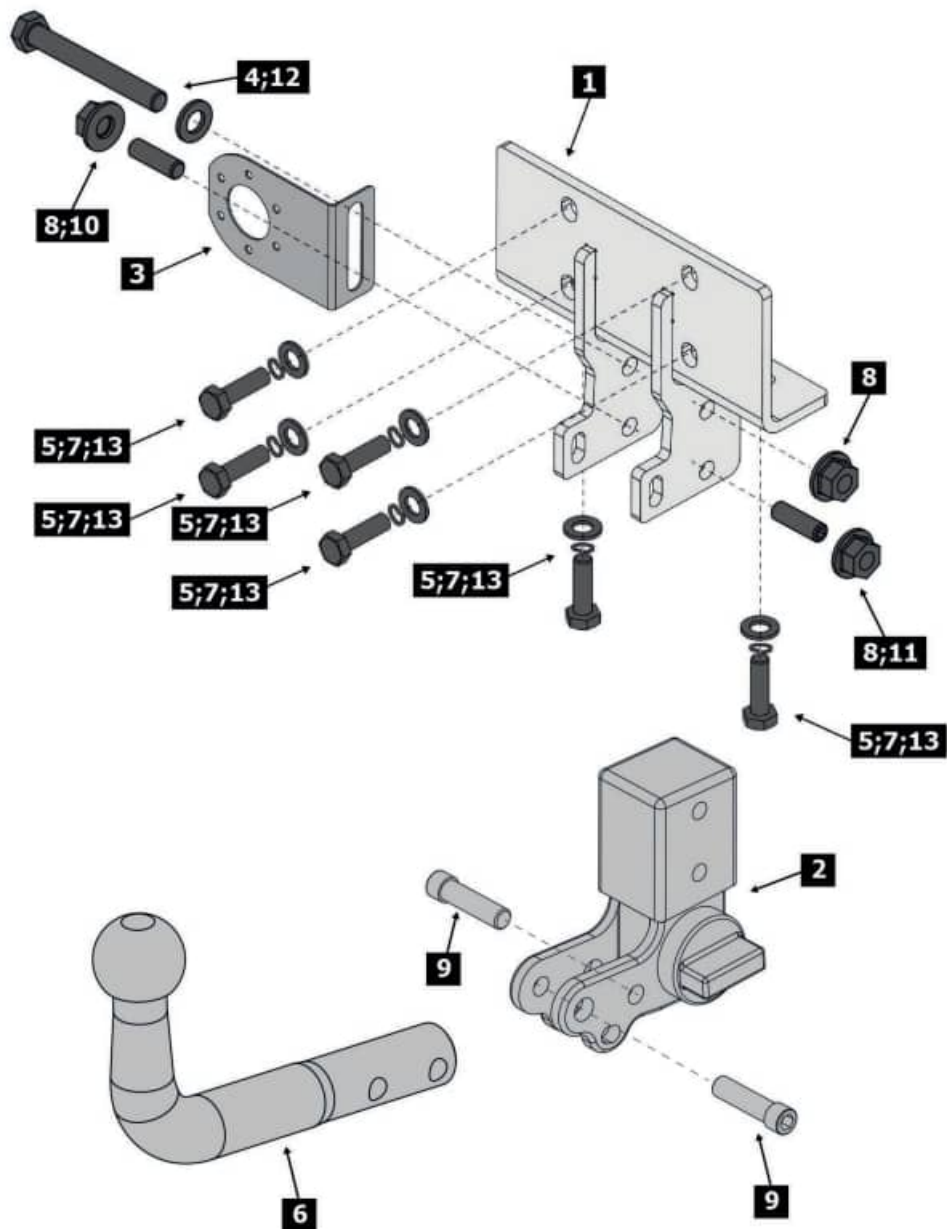
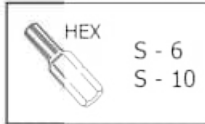
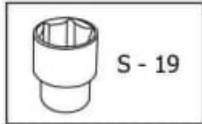

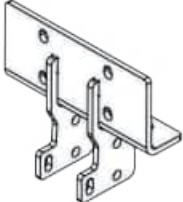
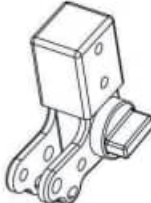
Вкрутить/выкрутить не затягивая

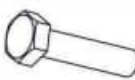

Расположение

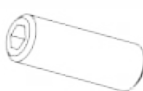
Используемый инструмент:

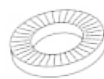

1	x1	Кронштейн	
2	x1	Быстросъём	
3	x1	Подрозетник	
4	x1	M12x100	
5	x6	M12x1.25x40	
6	x1	Крюк	
7	x6	Ø12	
8	x3	M12	
9	x2	M12x45	
10	x1	Шпилька M12x25	
11	x1	Шпилька M12x35	
12	x1	Ø12	
13	x6	Ø12	

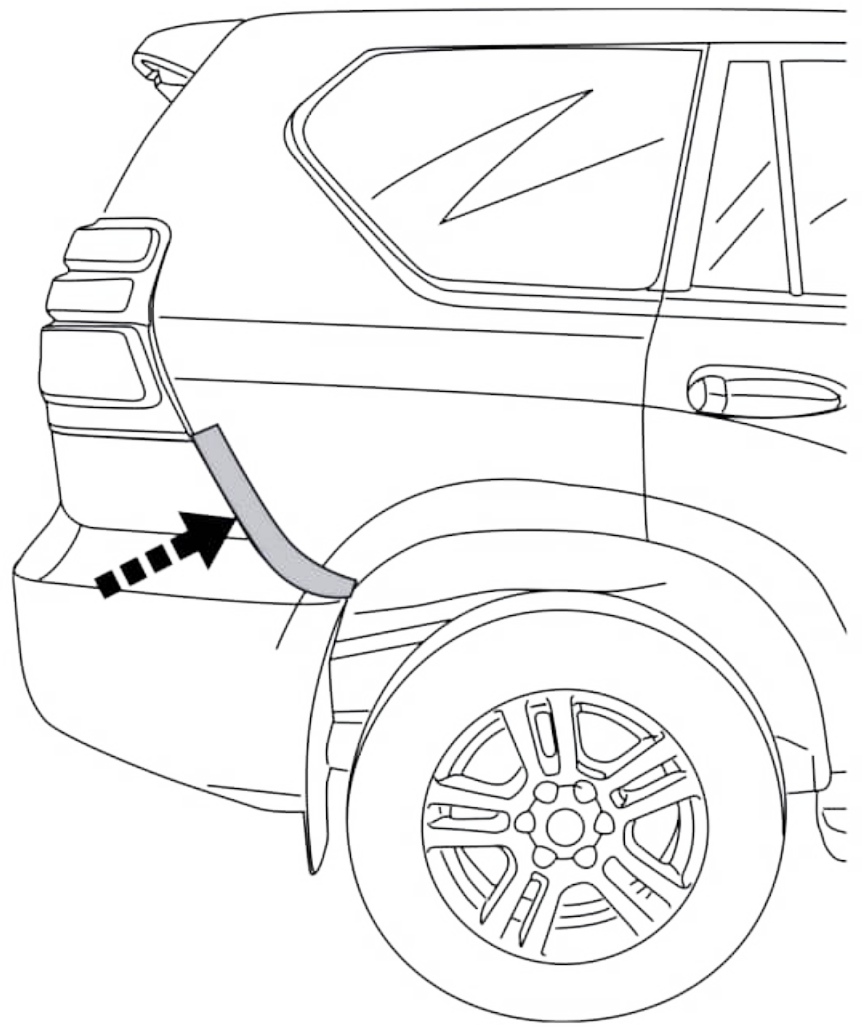
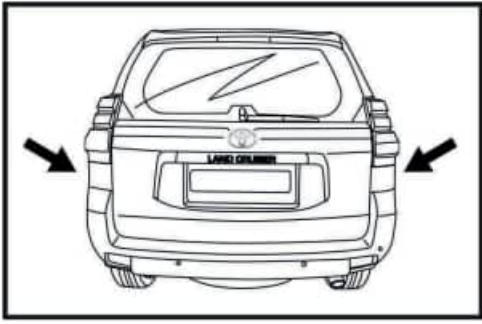

1

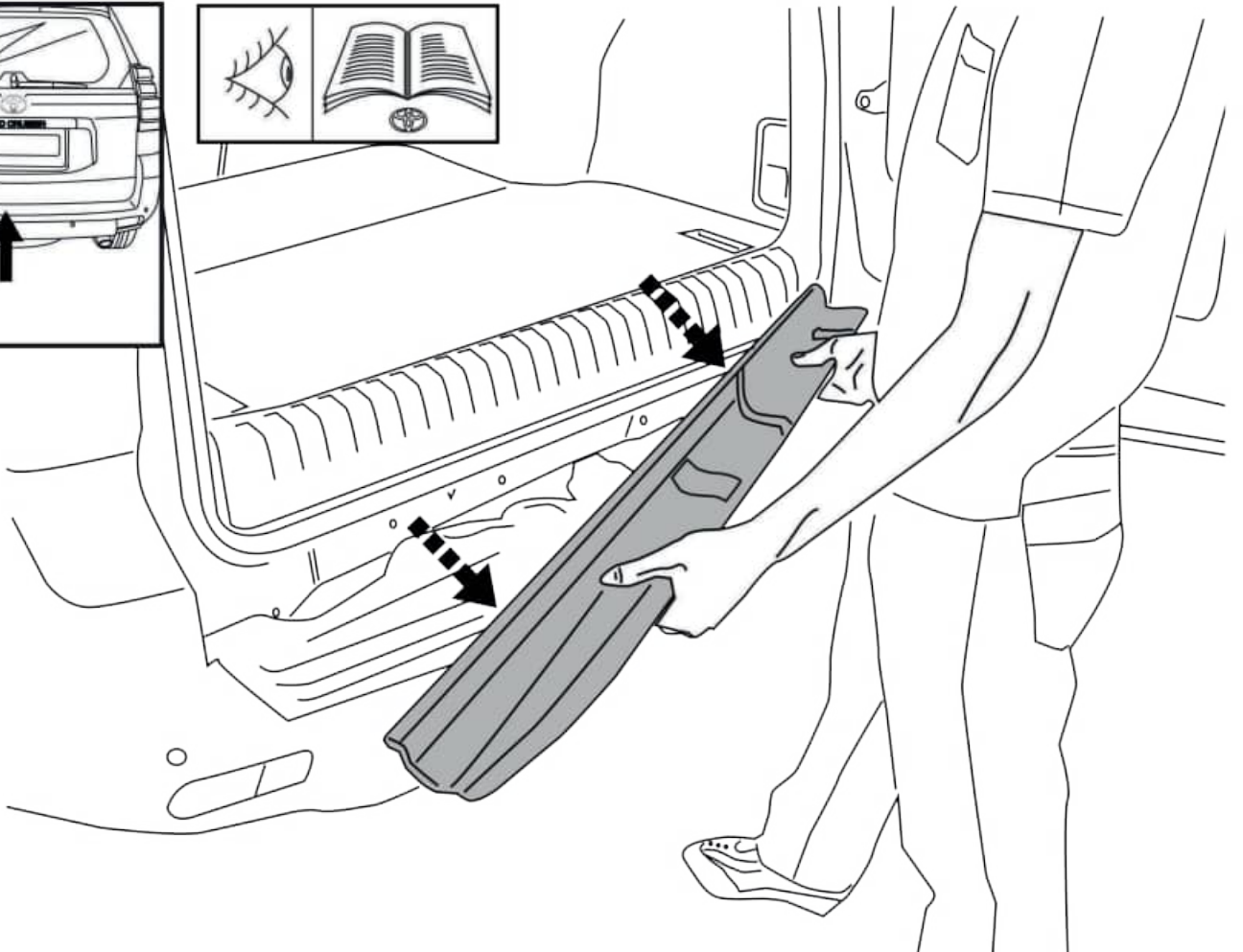
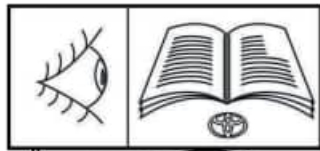
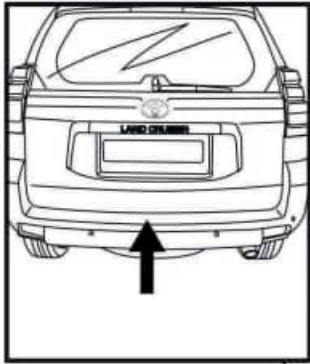

2

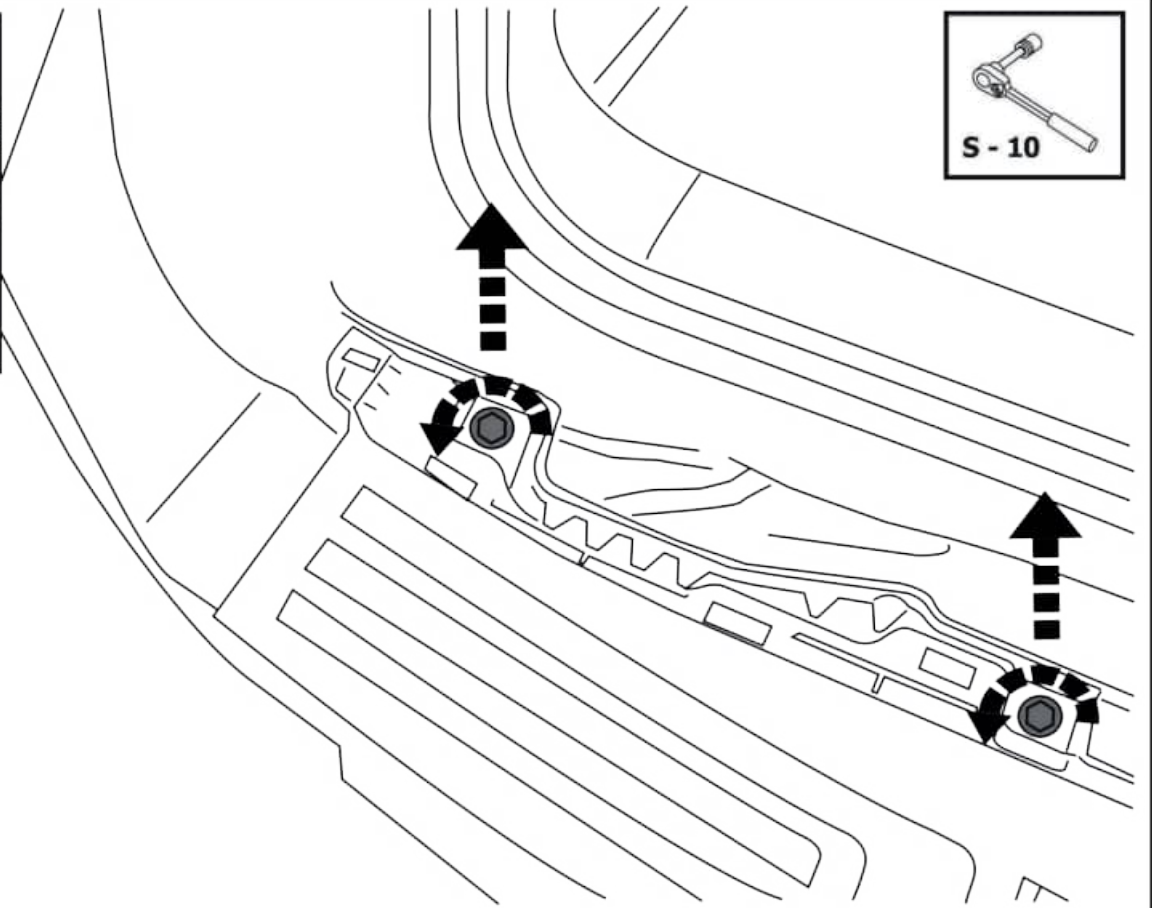
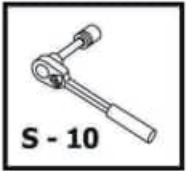
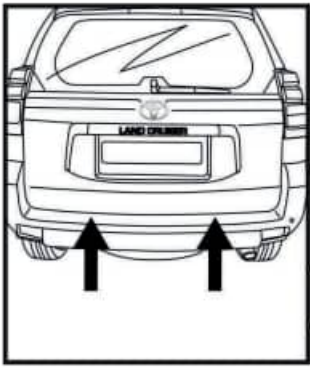

3

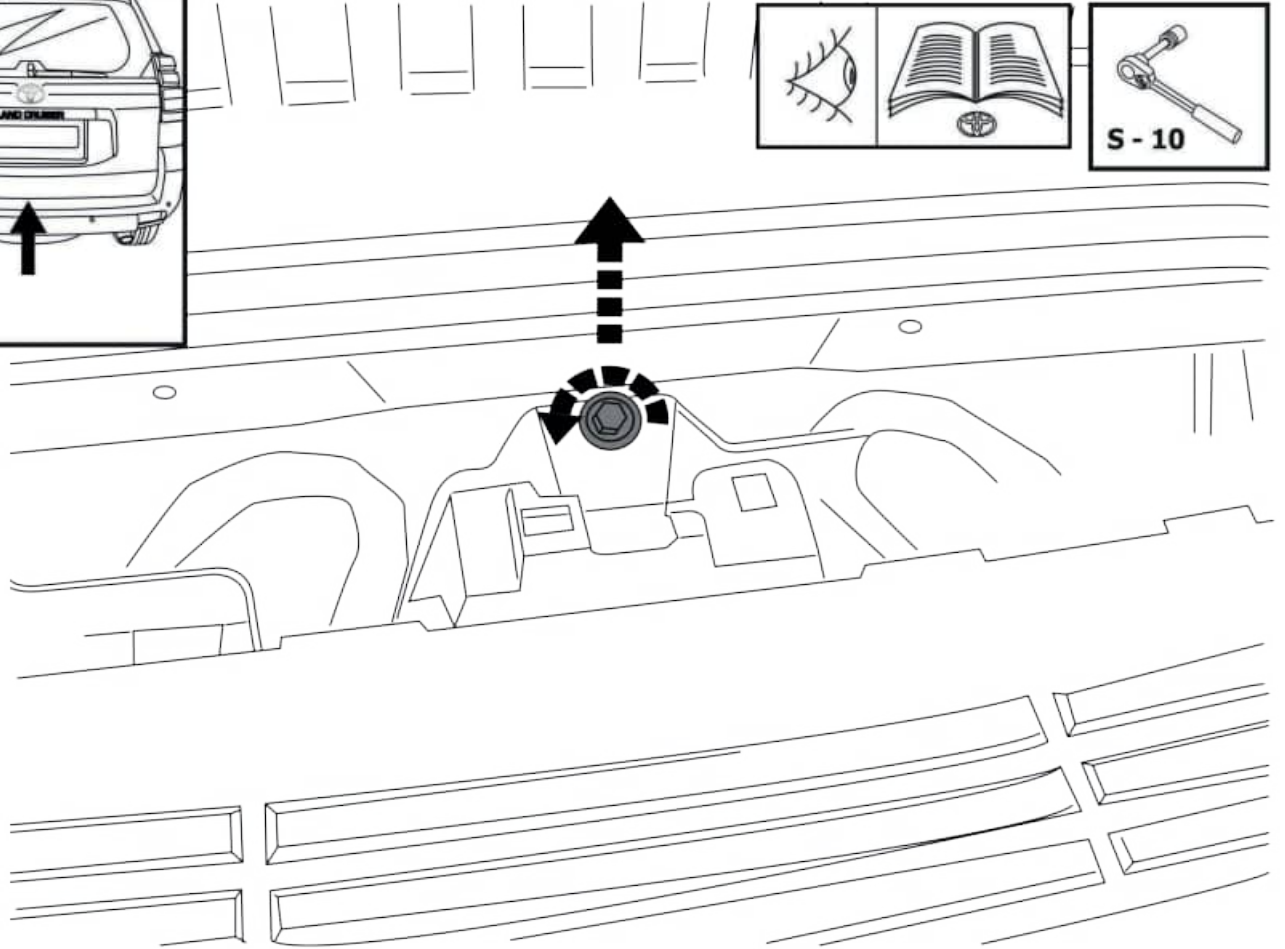
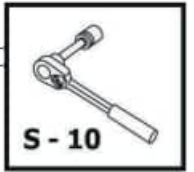
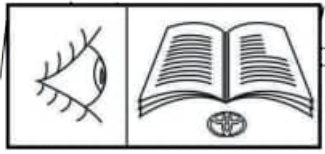
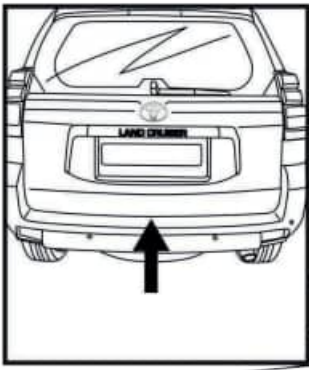

4

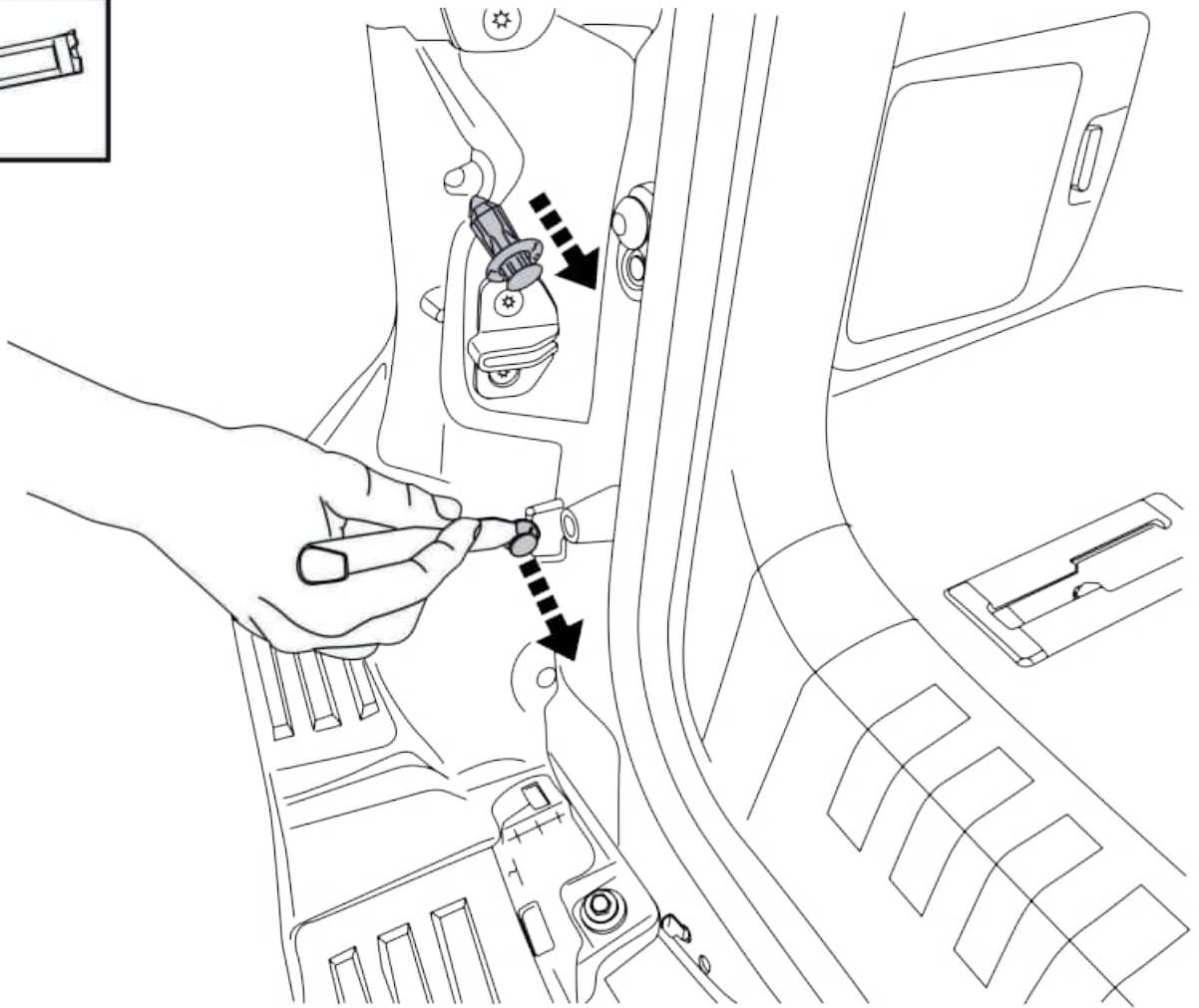
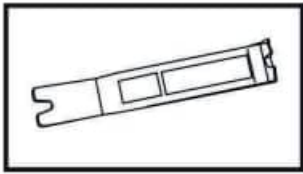

5

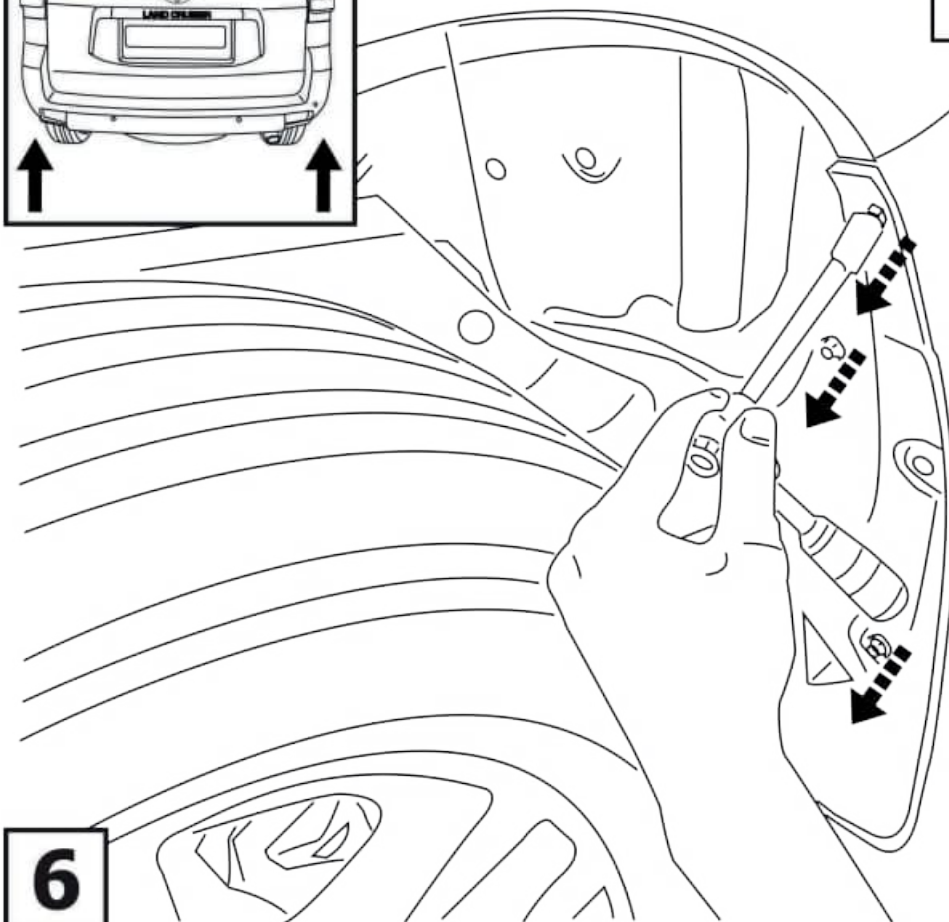
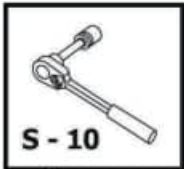
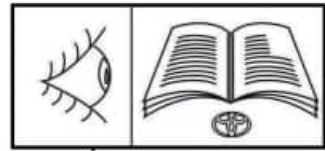
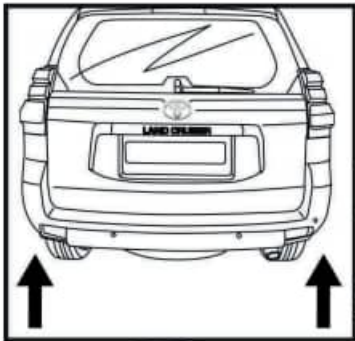

6

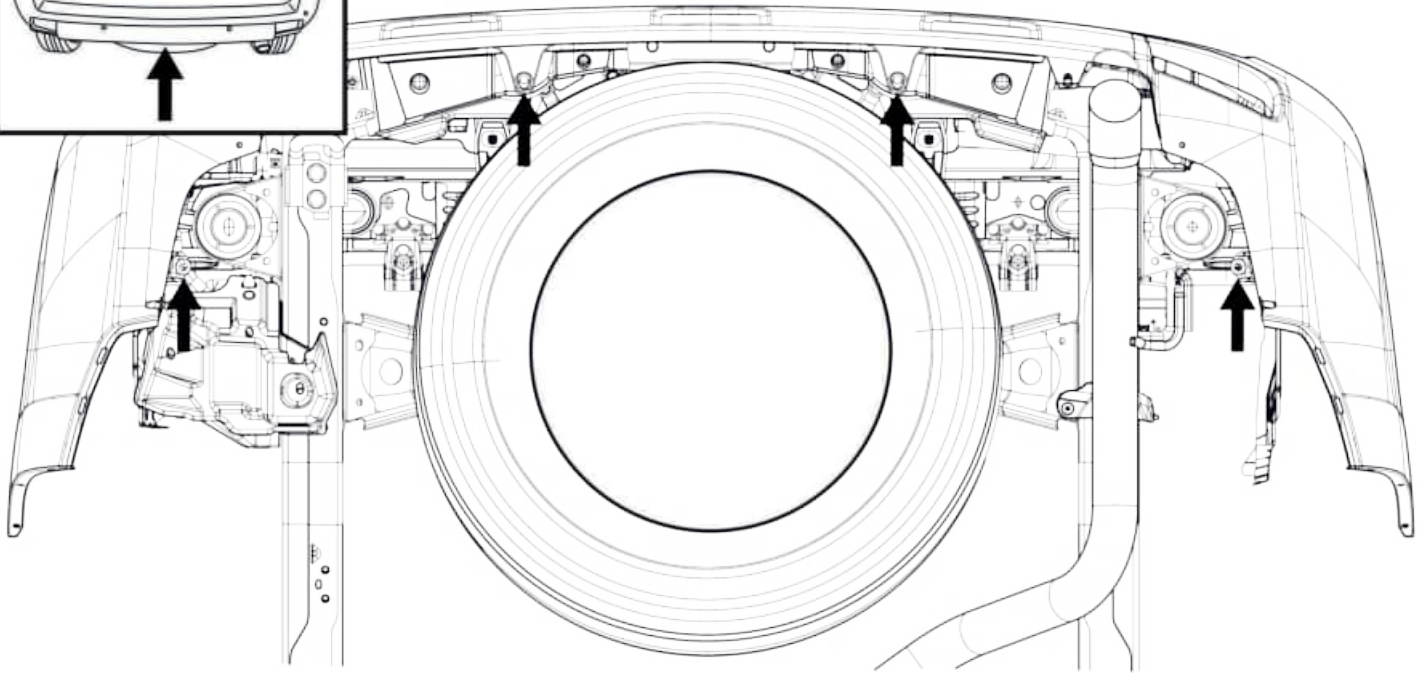
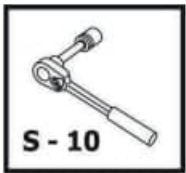
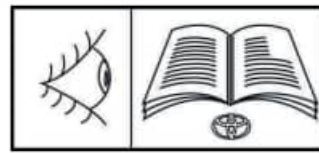
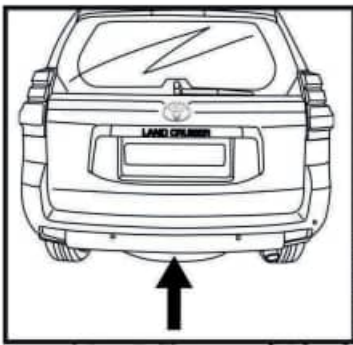

7

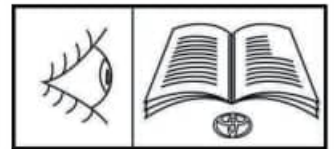
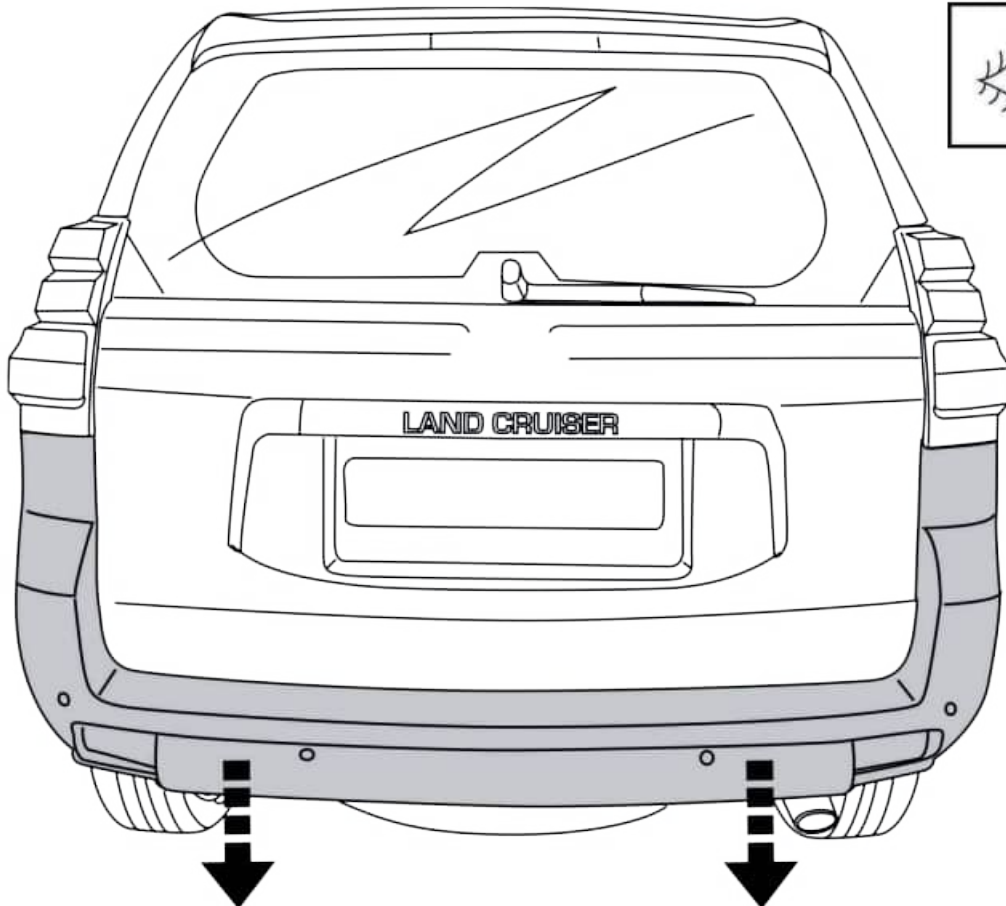

8

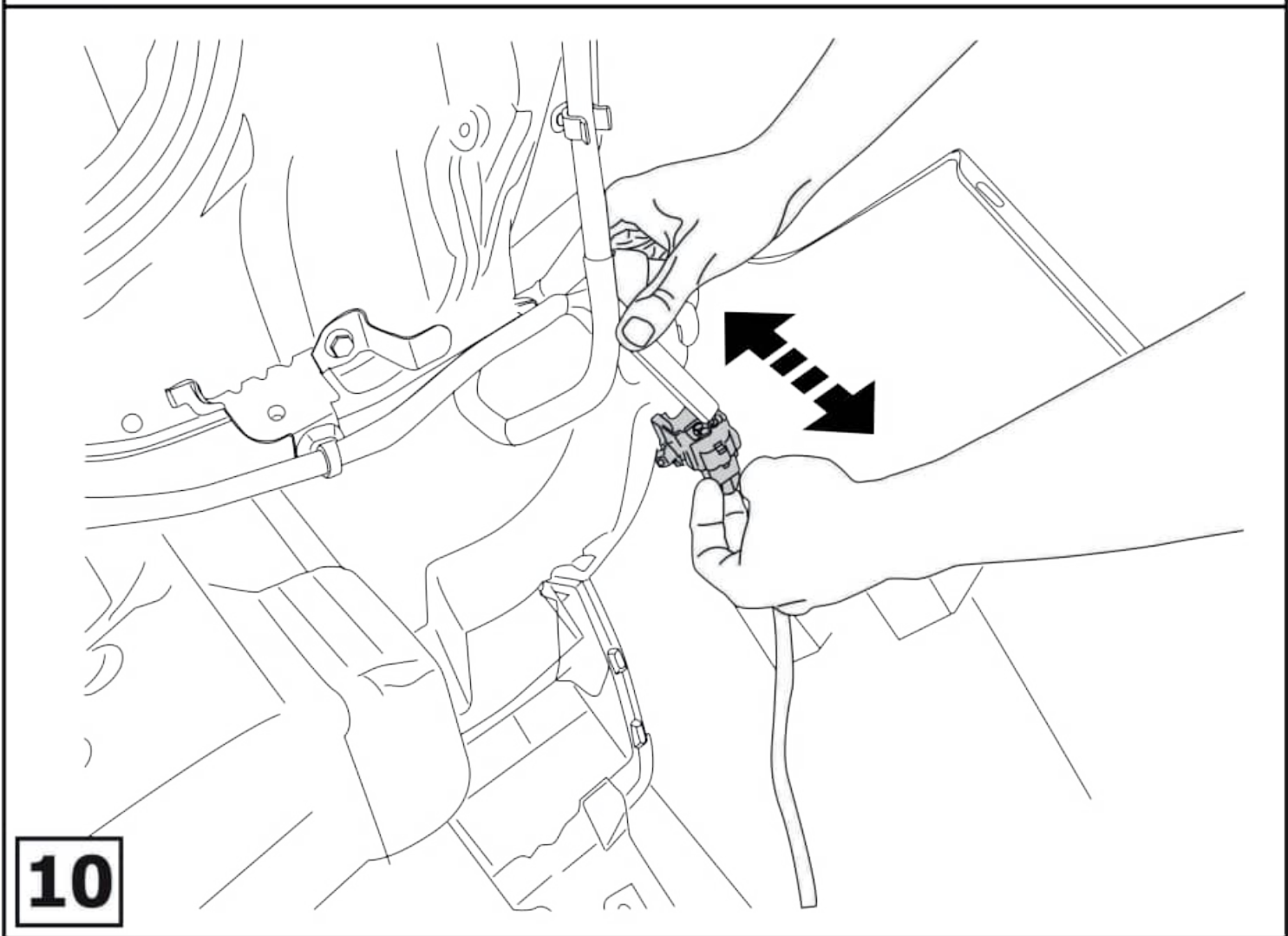
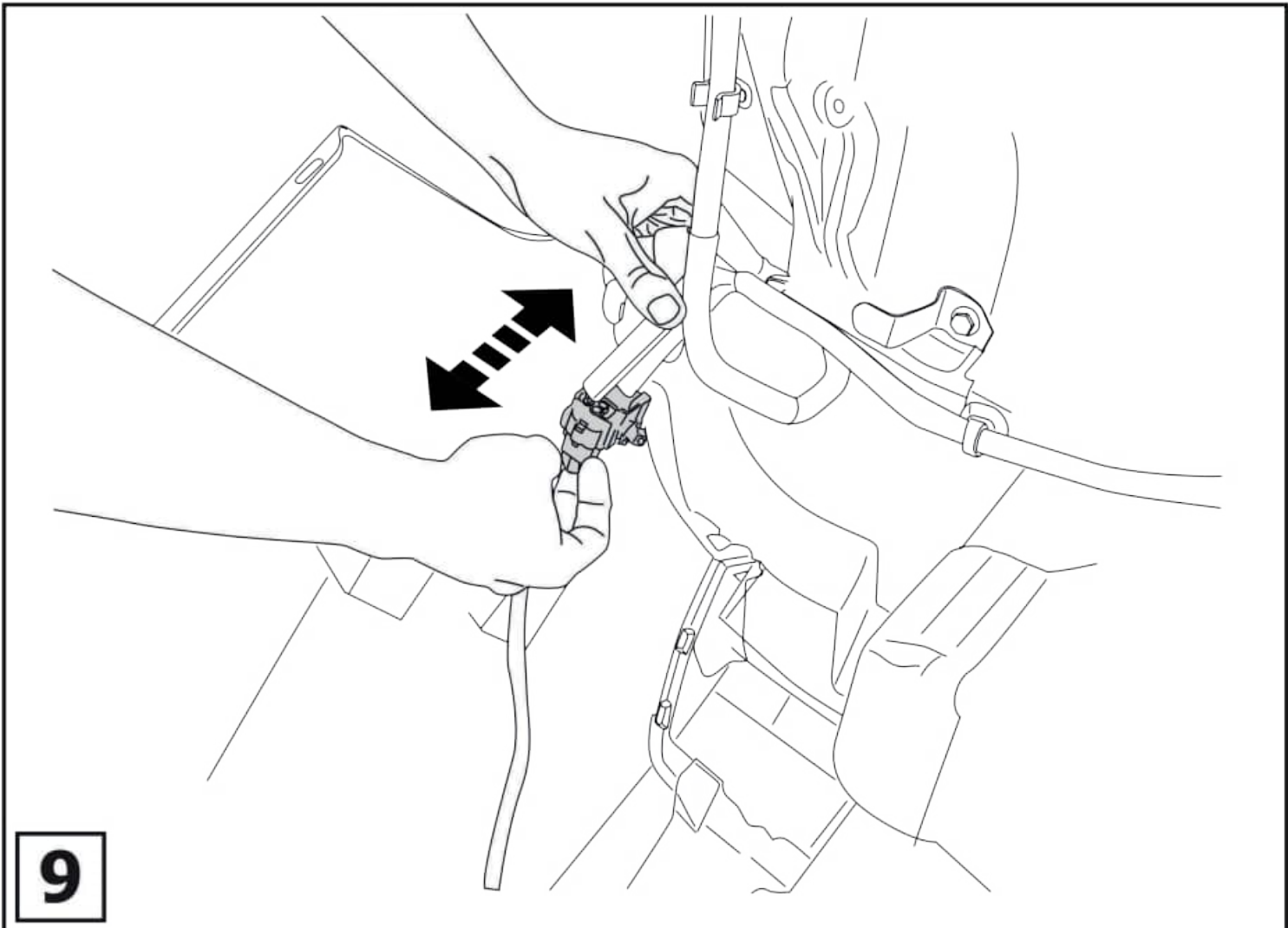

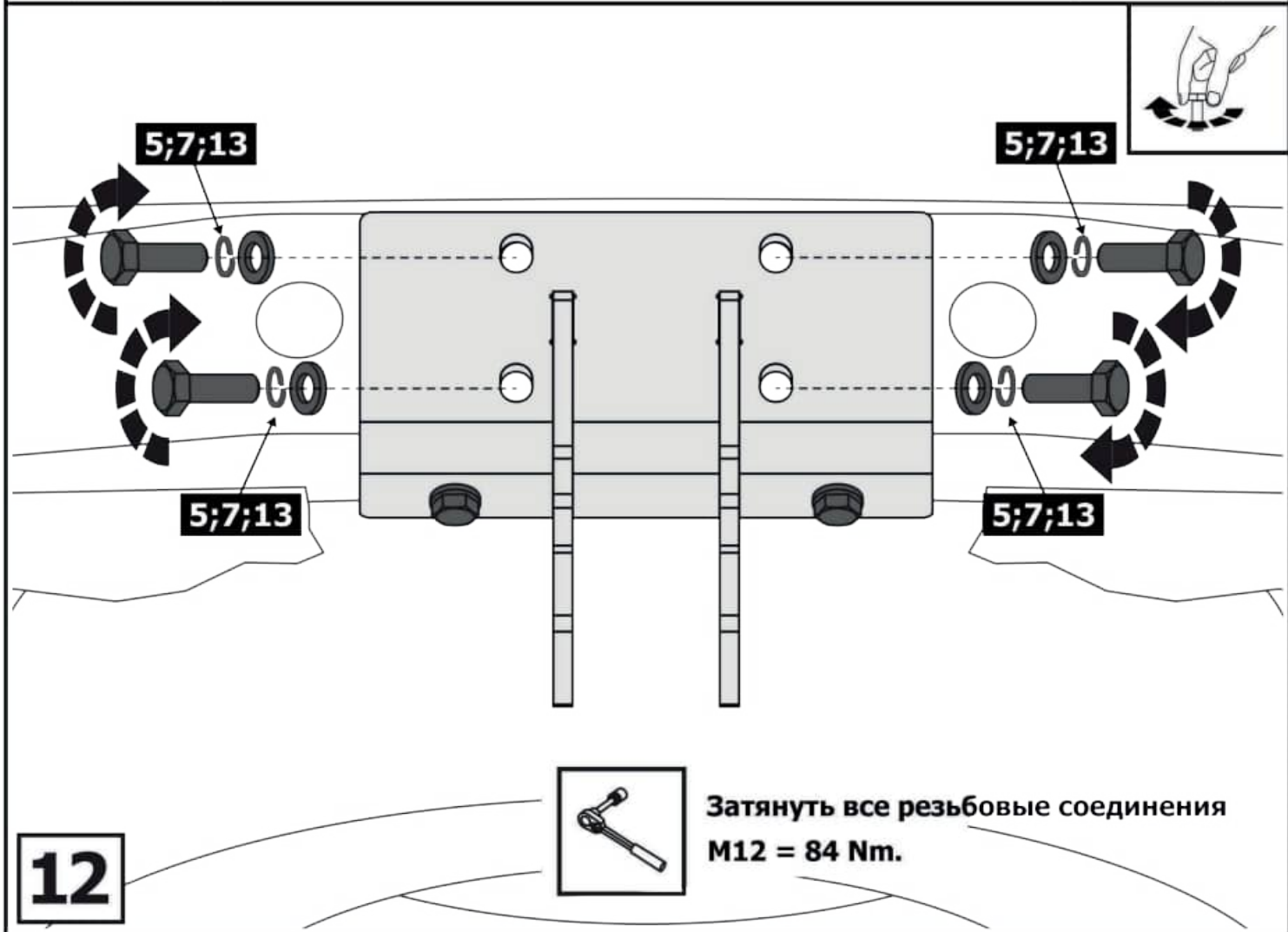
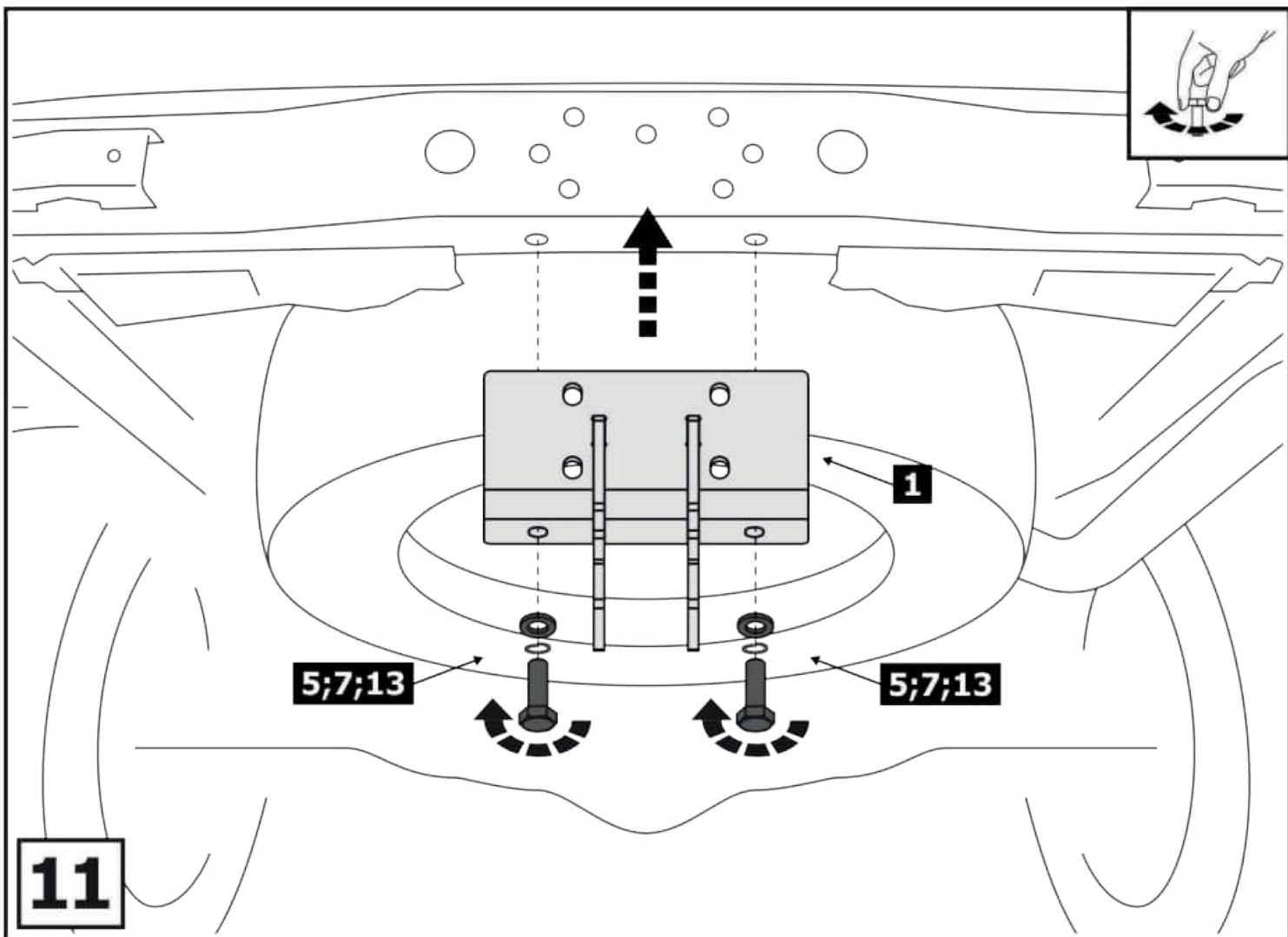

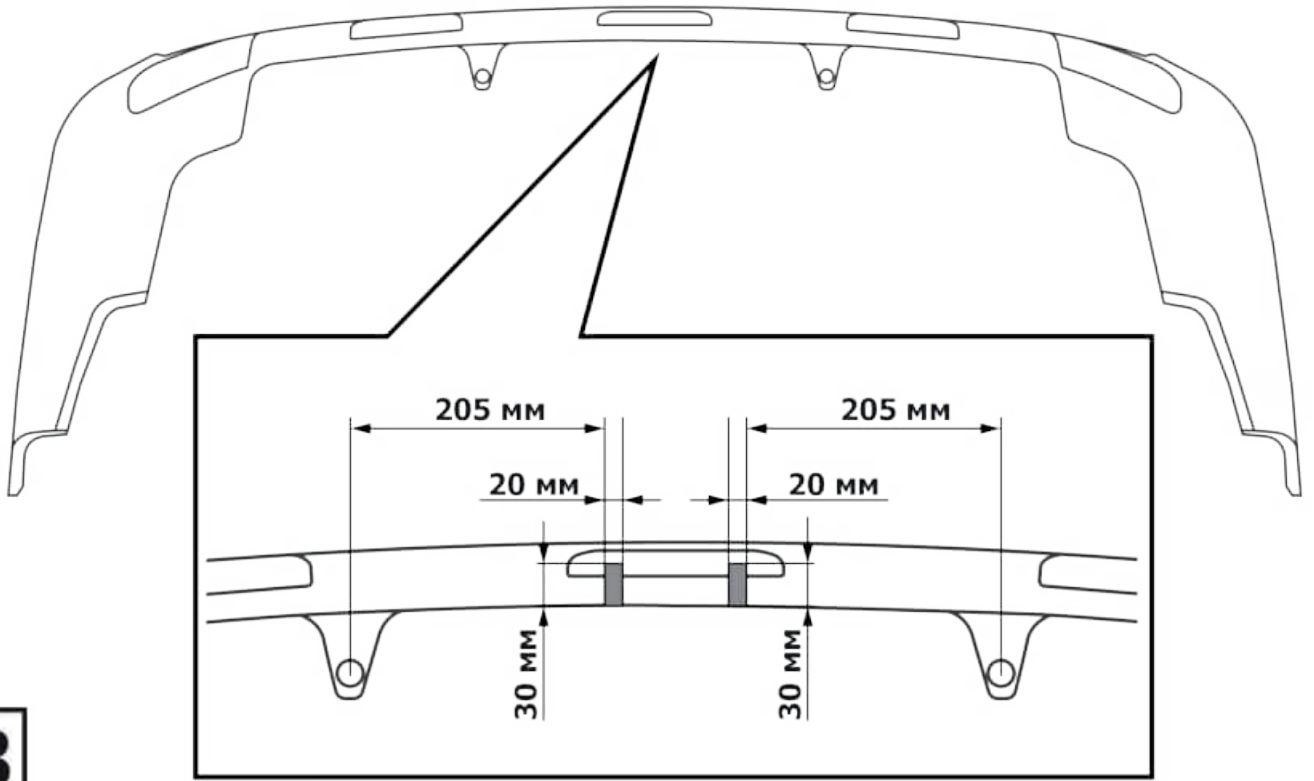
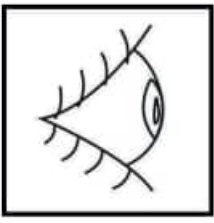

13

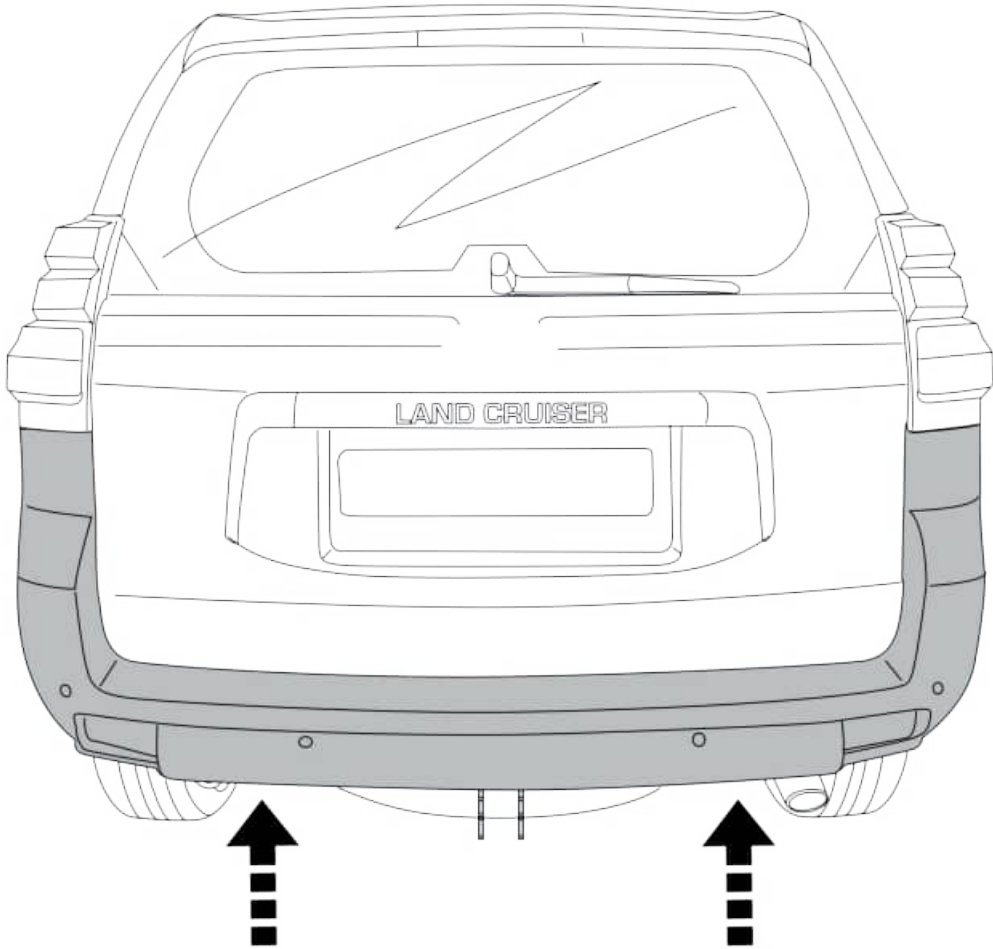

14

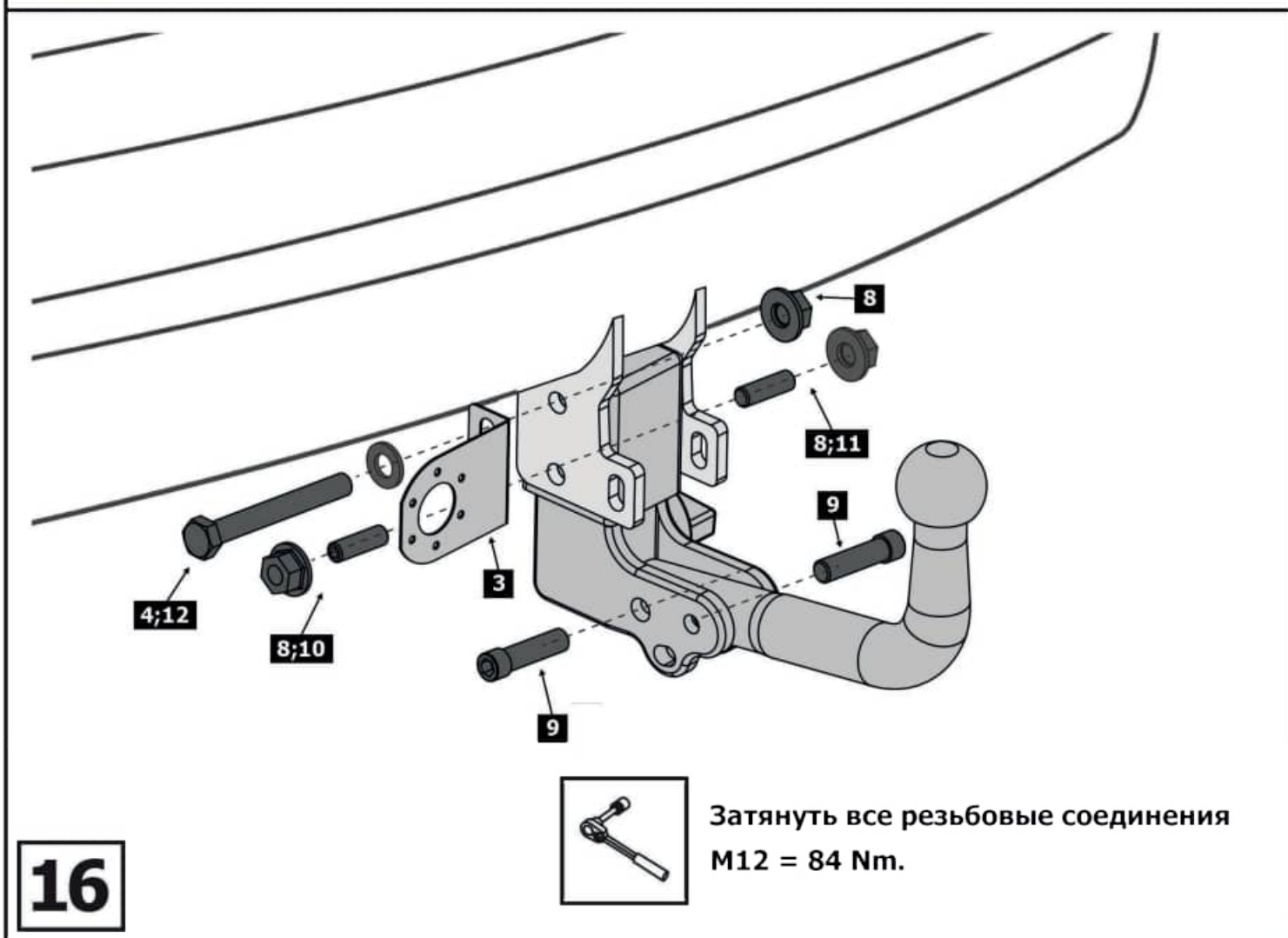
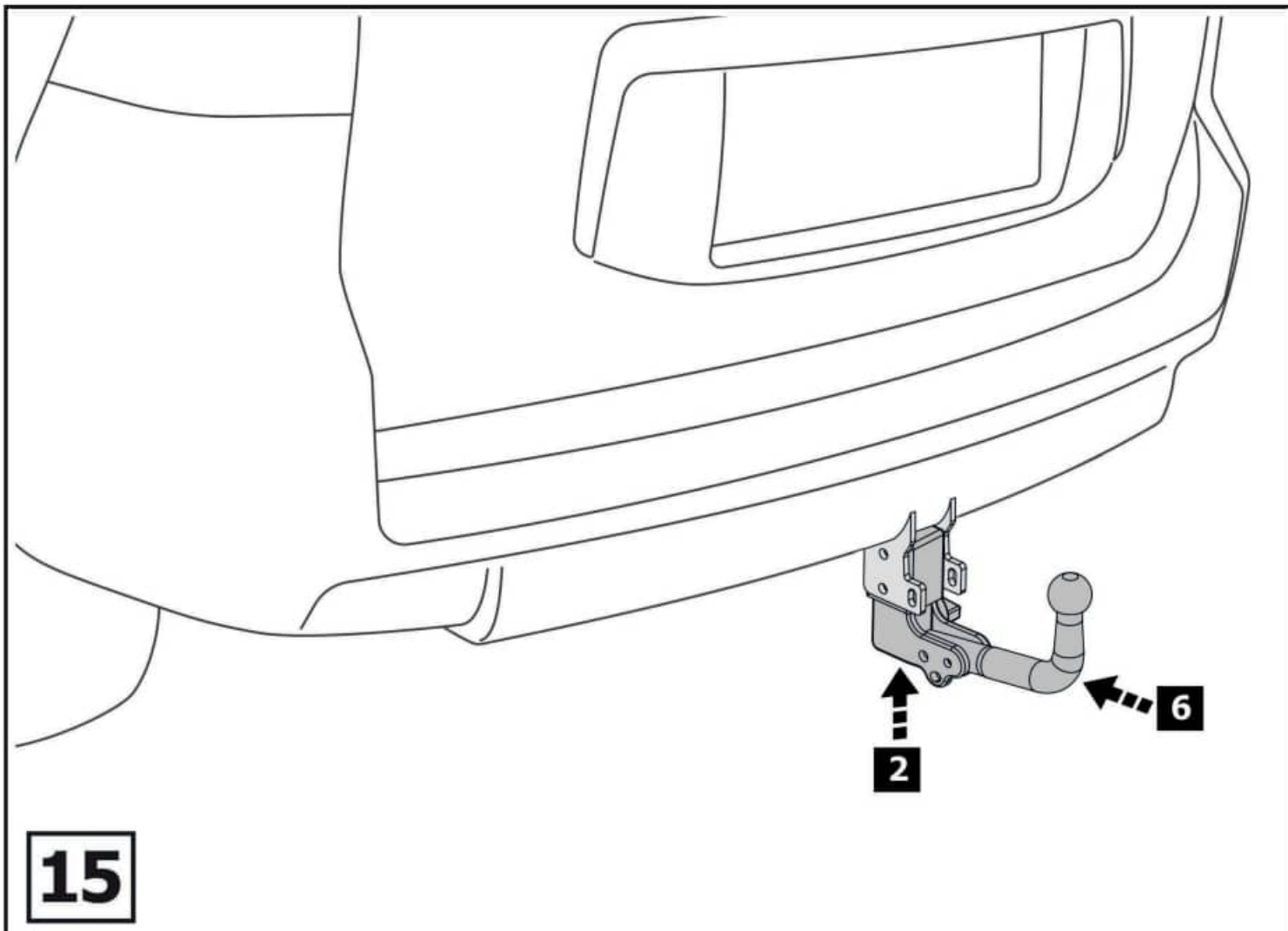

Затянуть все резьбовые соединения
M12 = 84 Nm.