

Инструкция по установке **HYUNDAI SOLARIS**



(2011-2017)

KIA RIO

(2011-2017)



Арт.: F.2313.001

 <p>1200 kg</p>	 <p>75 kg</p>	$D \text{ (kN)} = \frac{\text{MAX kg} \times \text{MAX kg}}{\text{MAX kg} + \text{MAX kg}} \times 0,00981$
<p>D = 6.7 kN</p>		

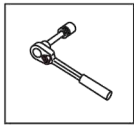

Вкрутить/выкрутить используя инструмент

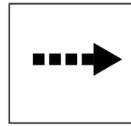

Движение

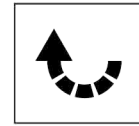

Поворот



Вкрутить/выкрутить не затягивая

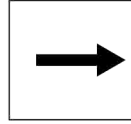





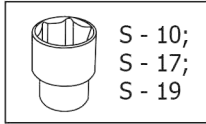
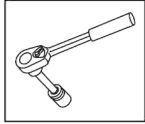

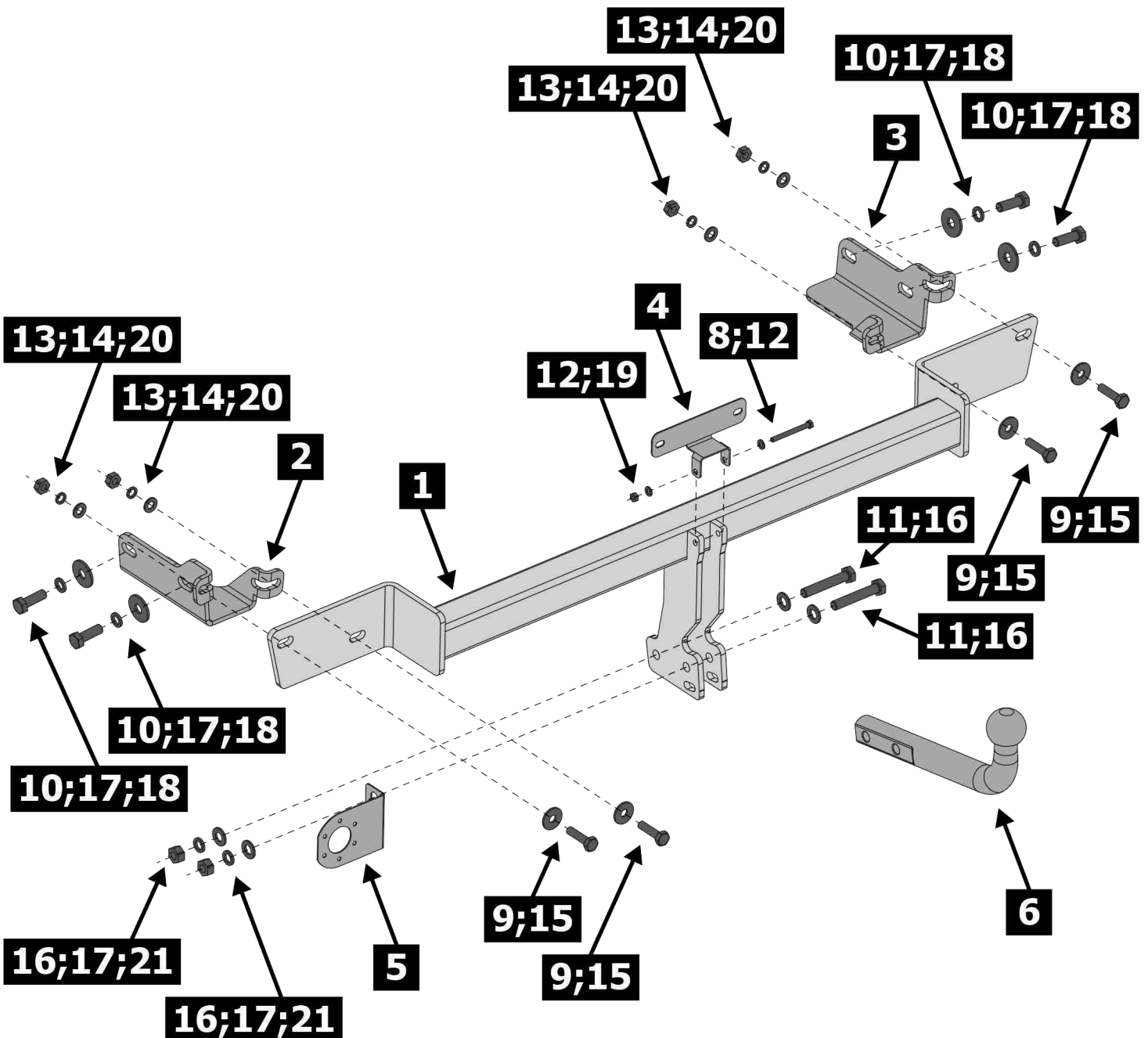

Расположение

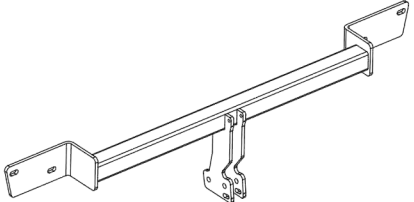
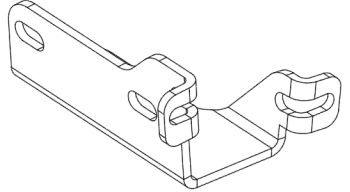
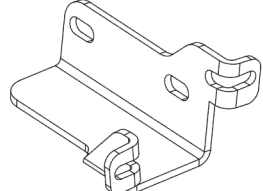
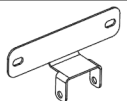
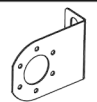
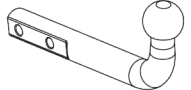
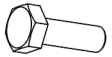
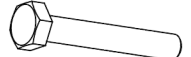

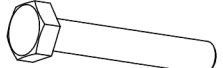
Используемый инструмент:



S - 10;
S - 17;
S - 19

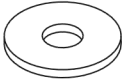

1	x1	Балка	
2	x1	Кронштейн левый	
3	x1	Кронштейн правый	
4	x1	Кронштейн антенны безключ. доступа	
5	x1	Подрозетник	
6	x1	Крюк	
7	x2	M6x20	
8	x1	M6x60	
9	x4	M10x40	
10	x4	M12x1.25X35	
11	x2	M12x1.25X70	
12	x6	ø 6	
13	x4	ø 10	
14	x4	ø 10	
15	x4	ø 10	
16	x4	ø 12	

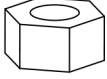
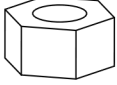
17	x4	∅ 12	
18	x6	∅ 12	
19	x3	M6	
20	x4	M10	
21	x2	M12x1,25	

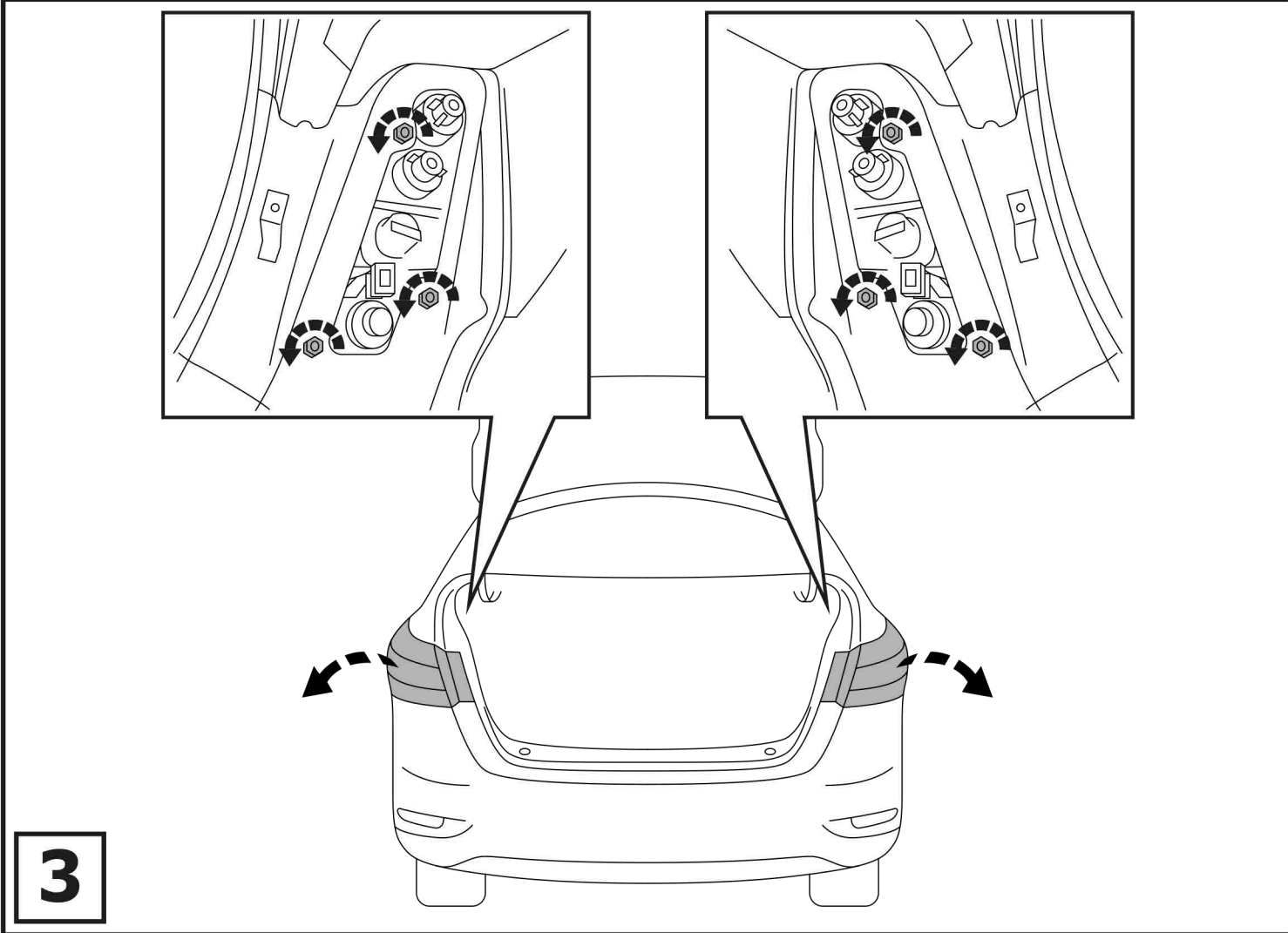
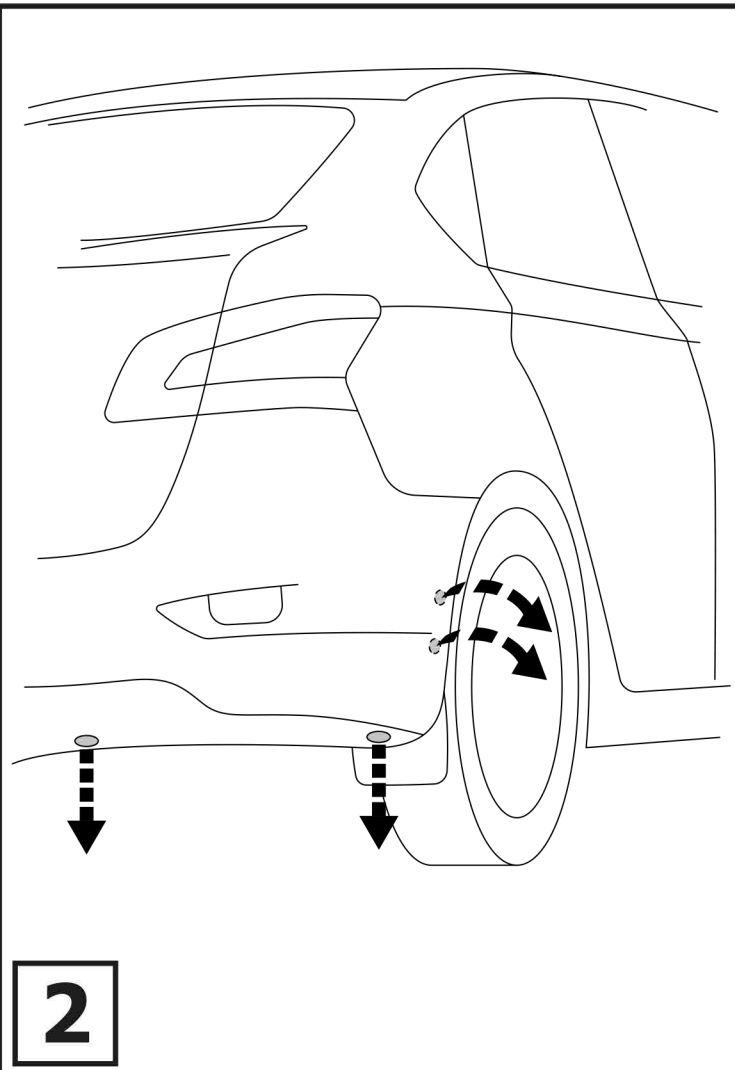
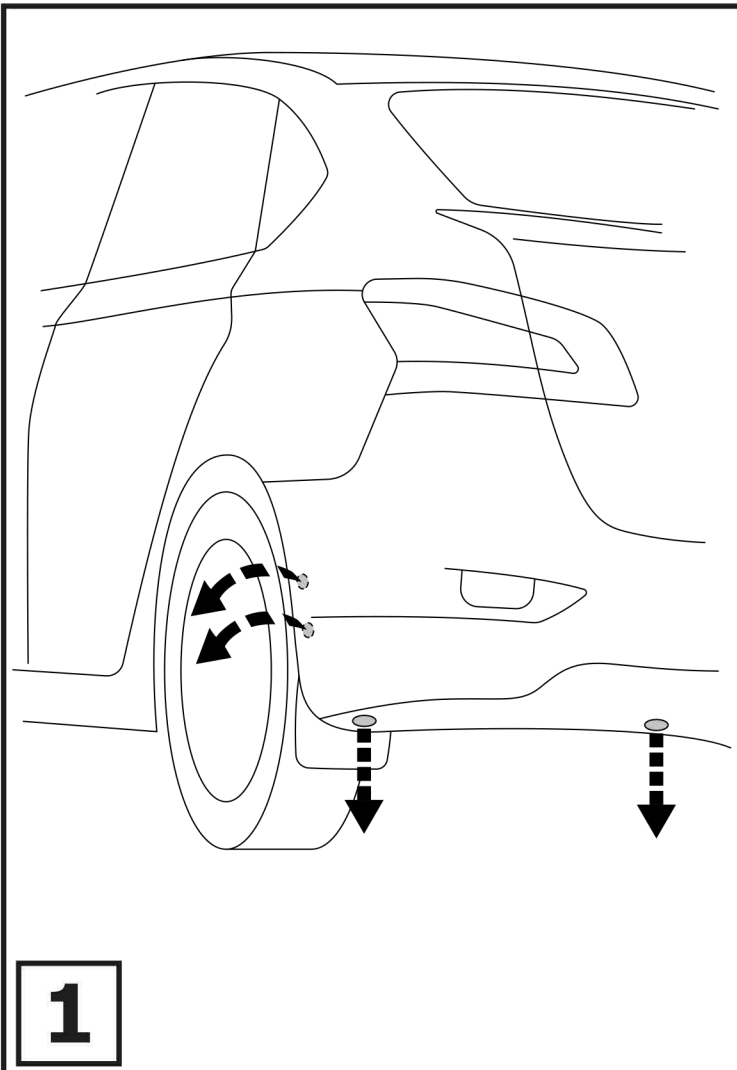

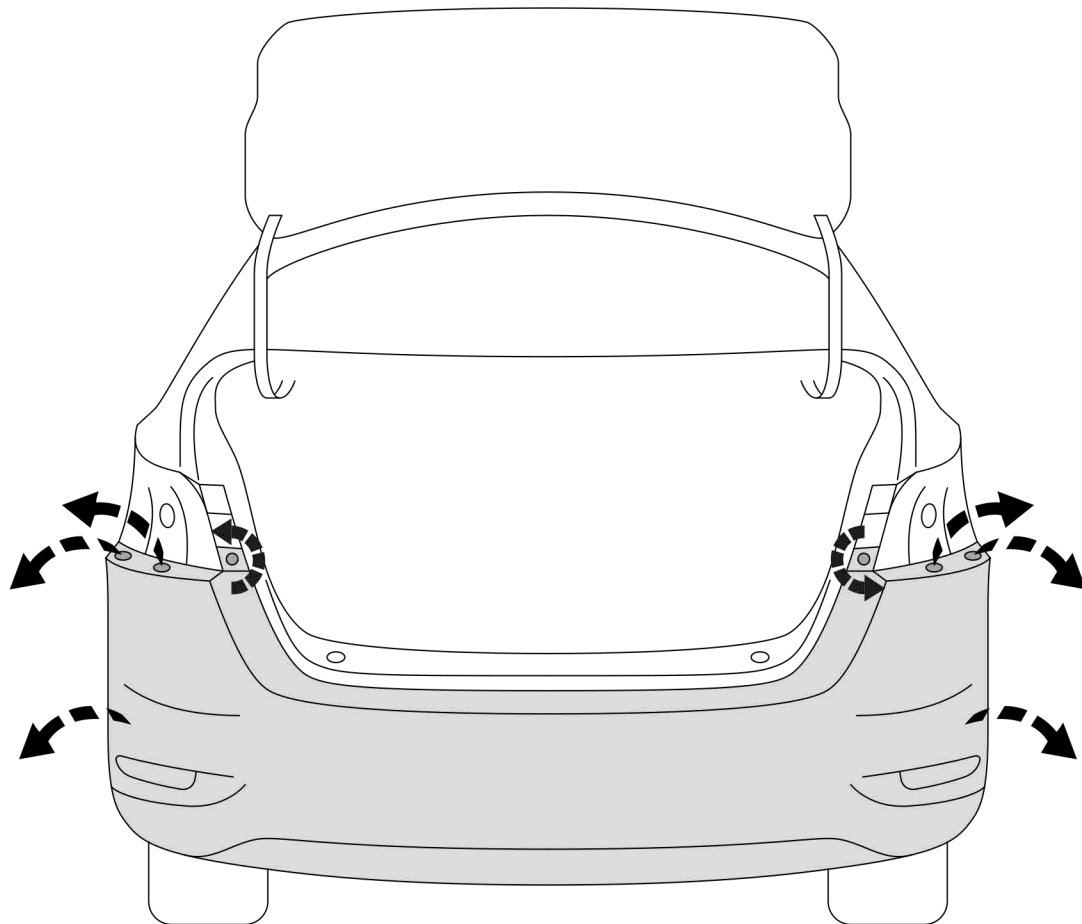

4

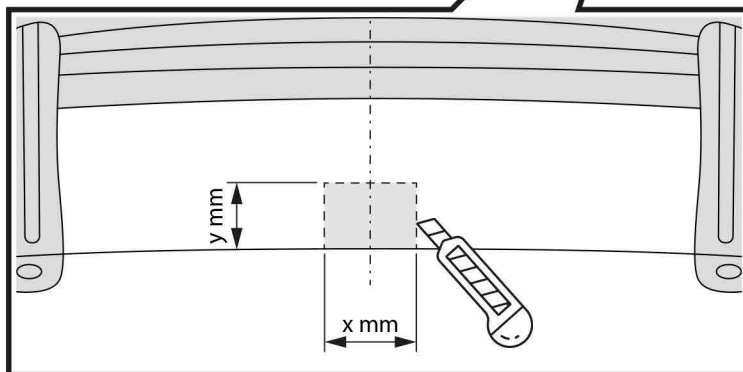
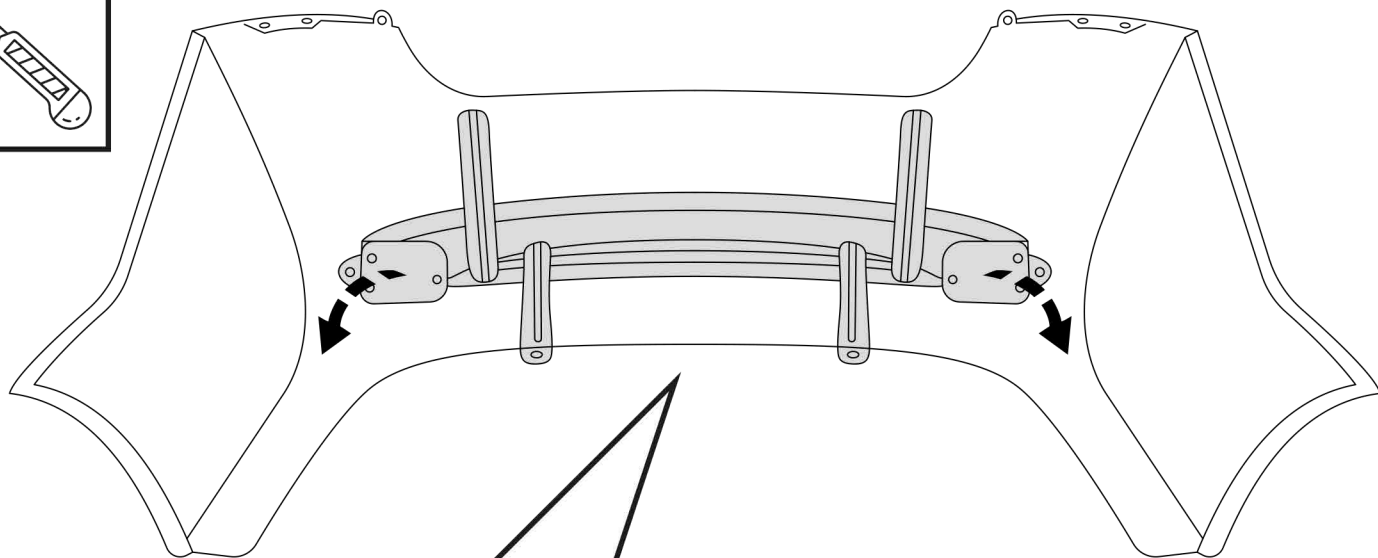
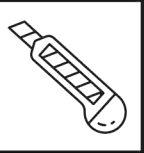

Hyundai Solaris Sedan	x=45 y=55
Hyundai Solaris Hatchback	x=45 y=30
KIA Rio Sedan	x=45 y=45
KIA Rio Hatchback	x=45 y=35

5

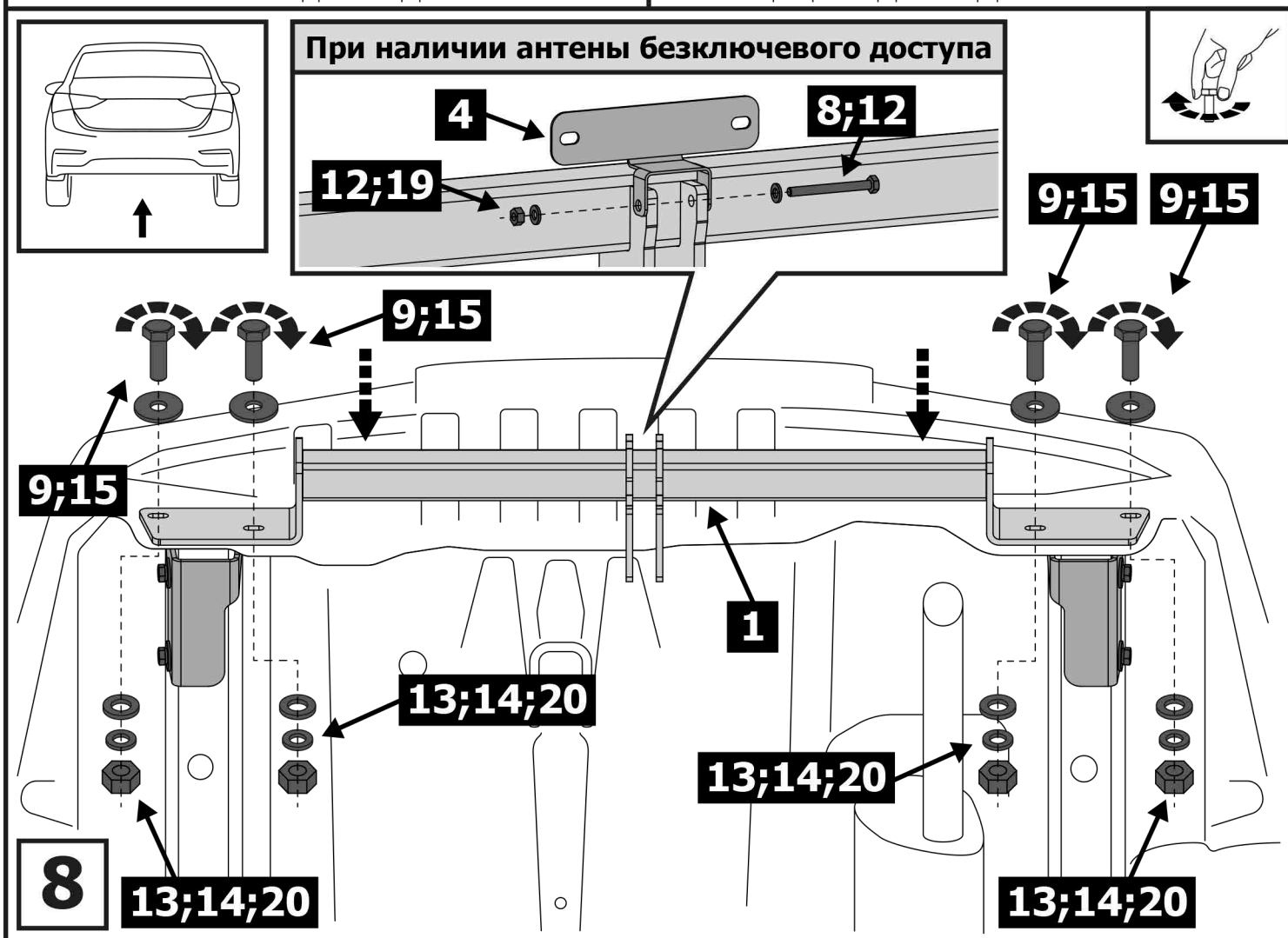
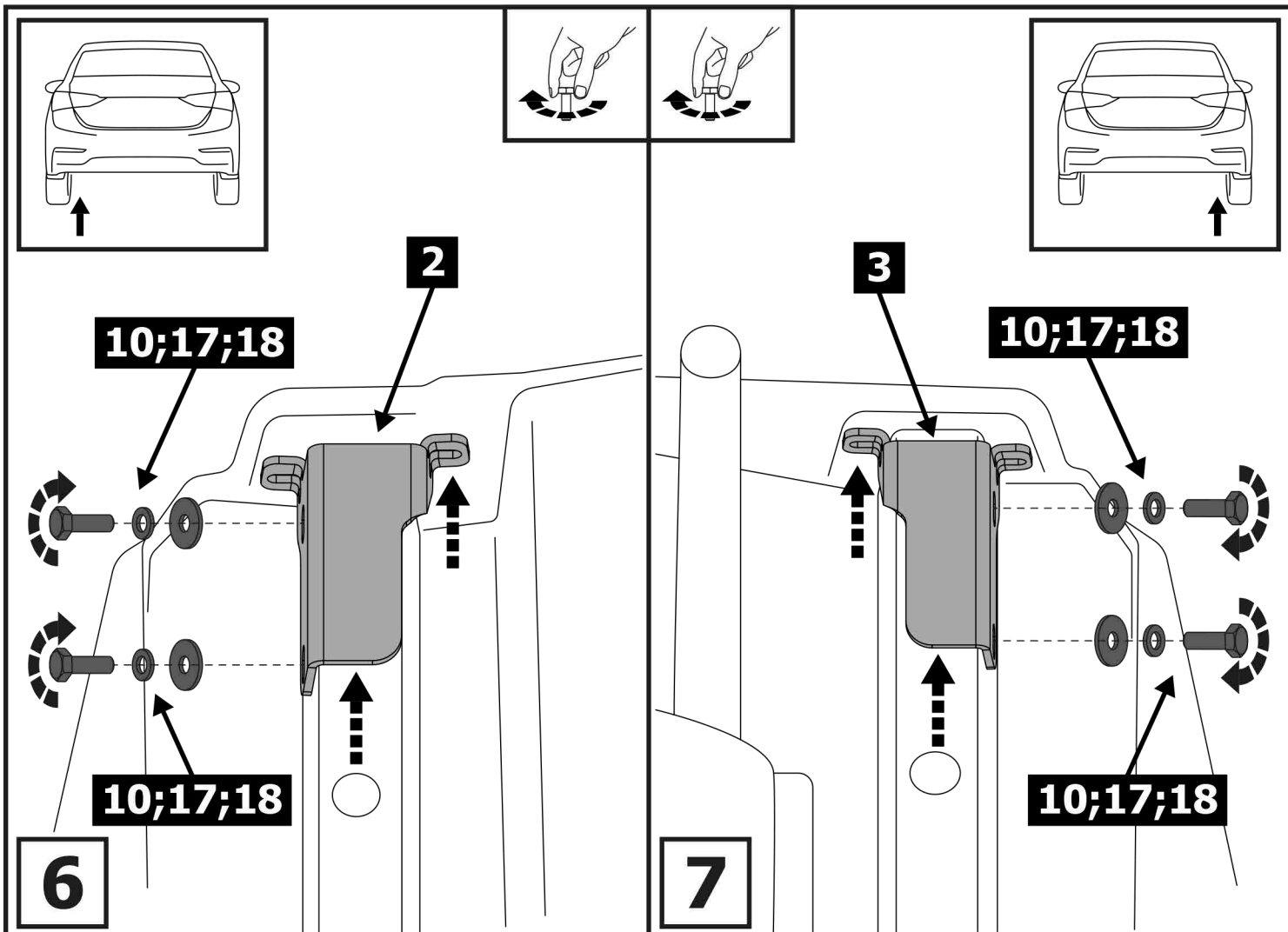

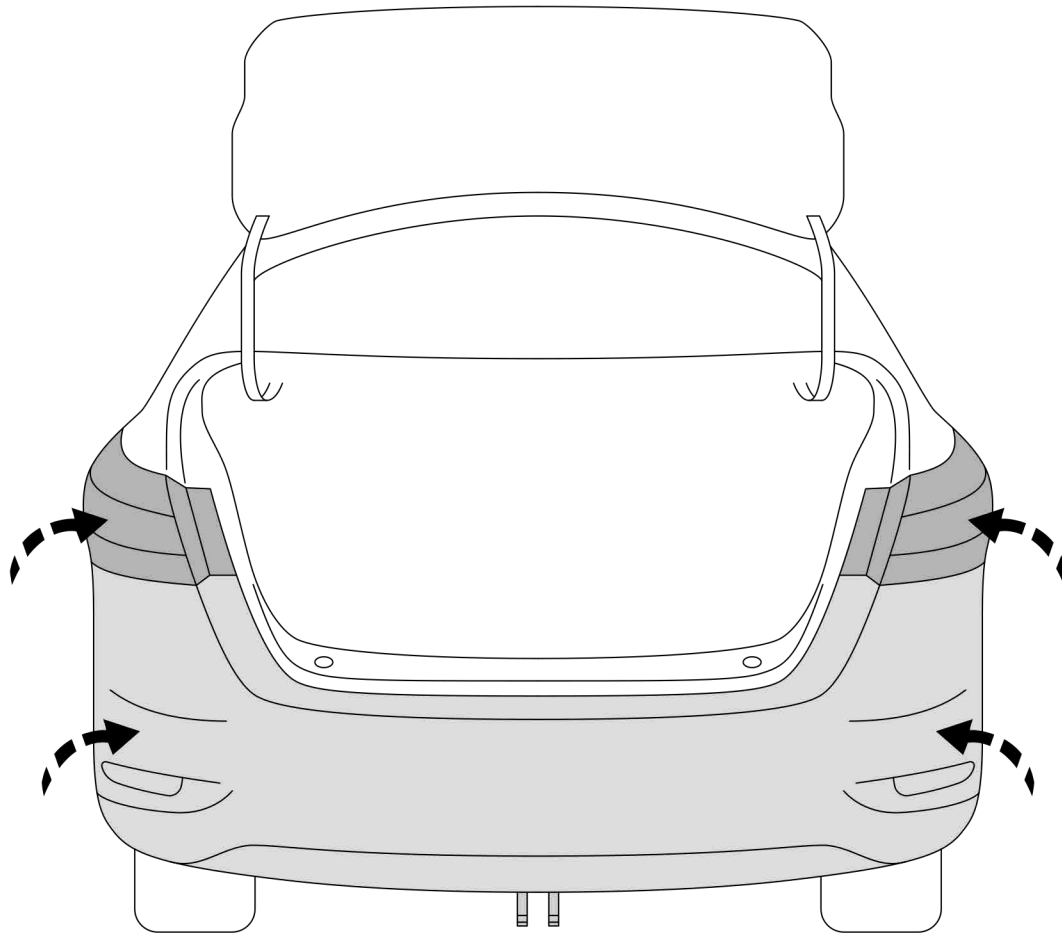

9

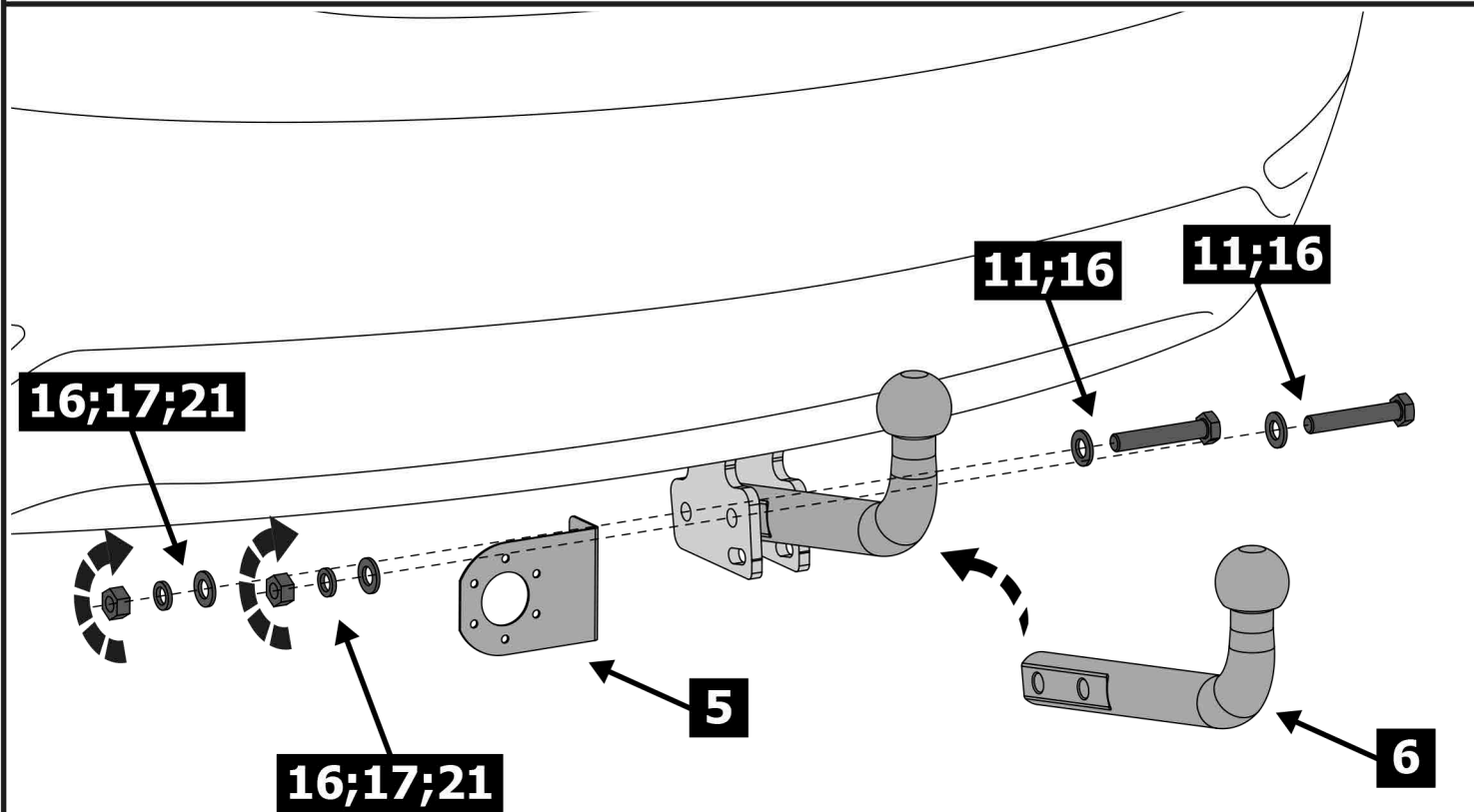

10



Затянуть все резьбовые соединения
 M6 = 9,5 Nm; M10 = 47 Nm; M12 = 84 Nm