

instructions

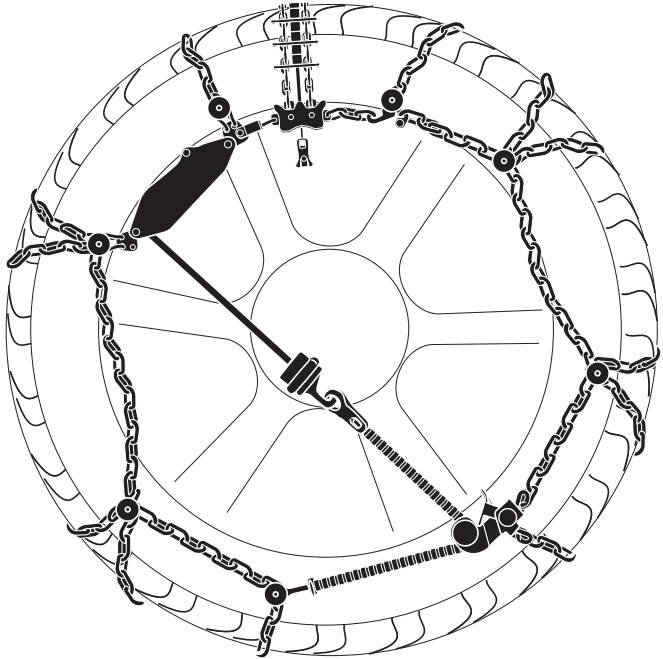

19 800 383

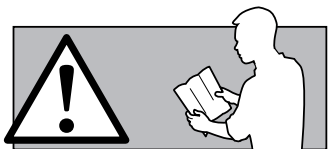

Optional

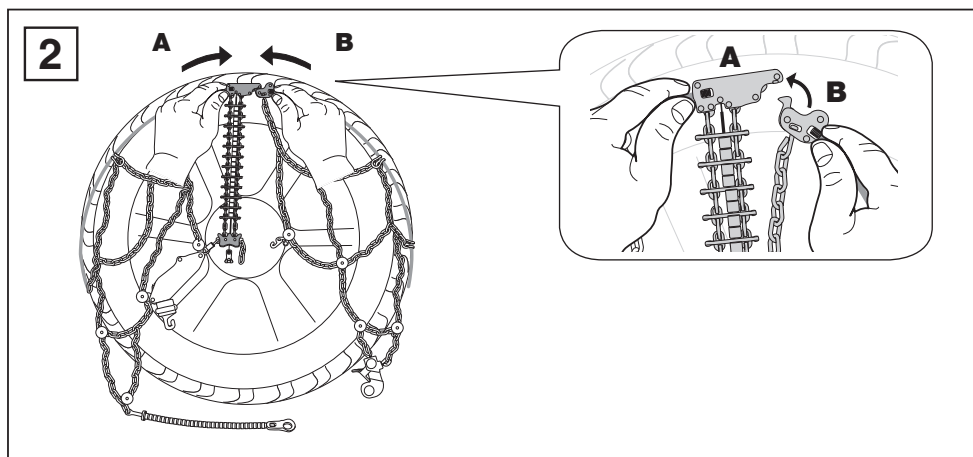
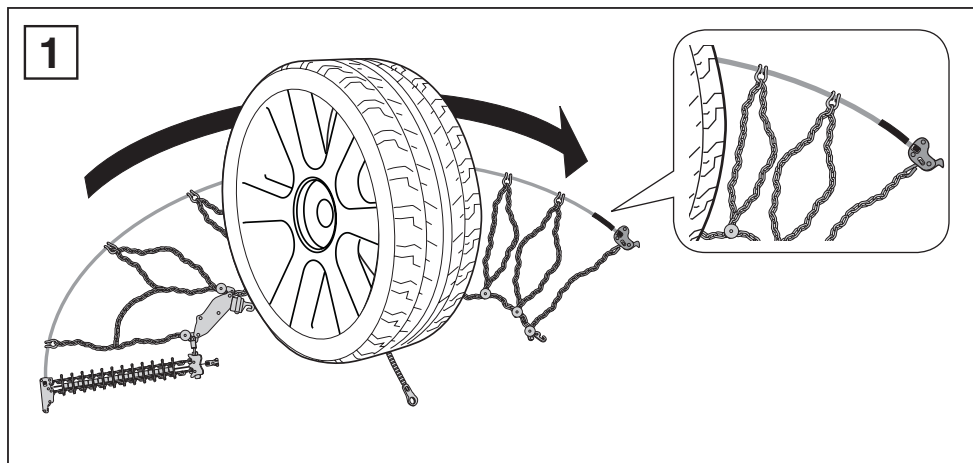
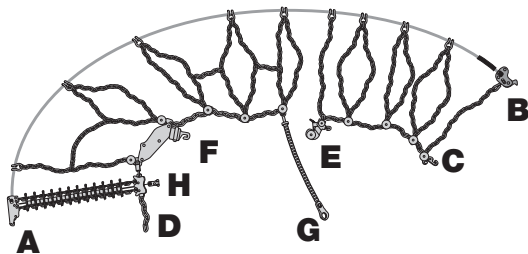
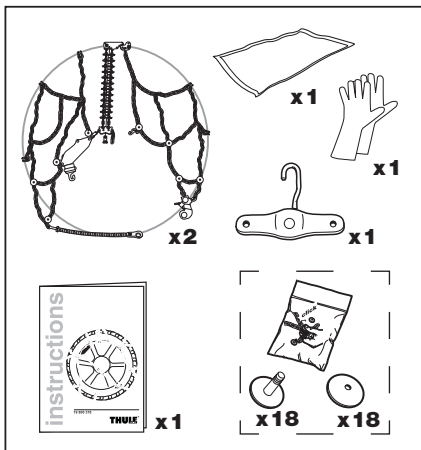
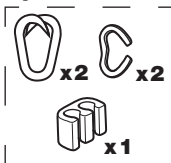

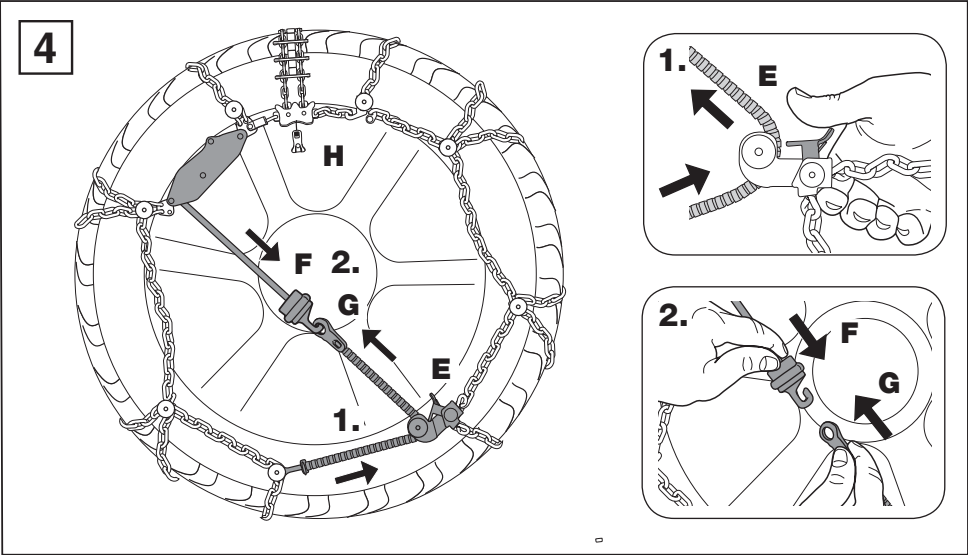
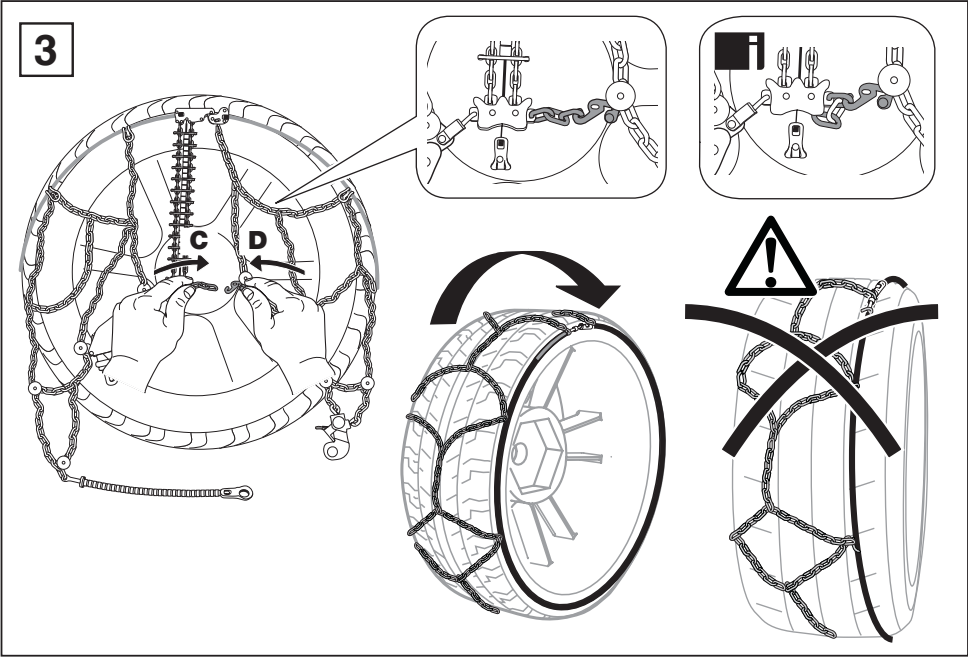

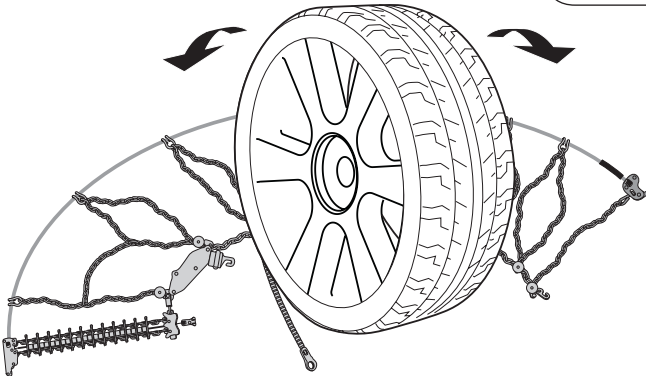
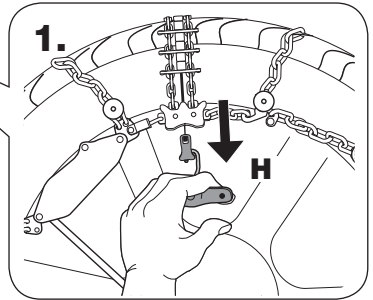
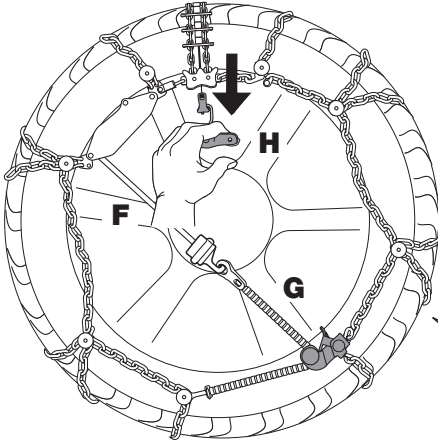
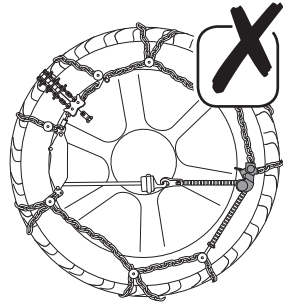
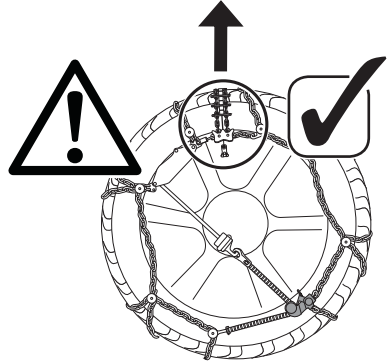
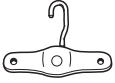
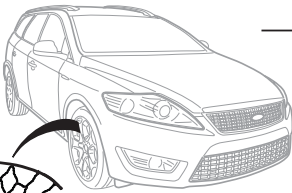

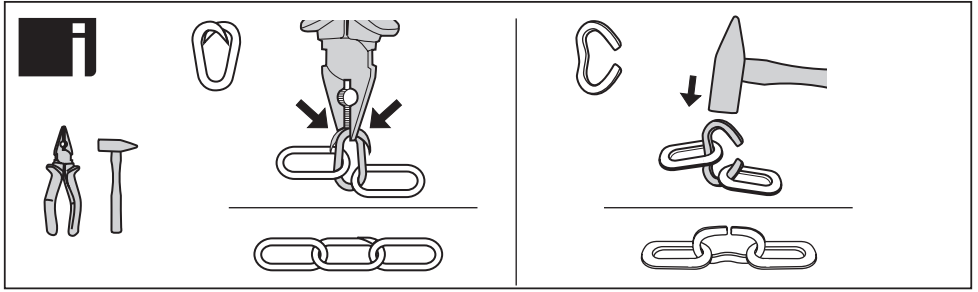

OPTIONAL

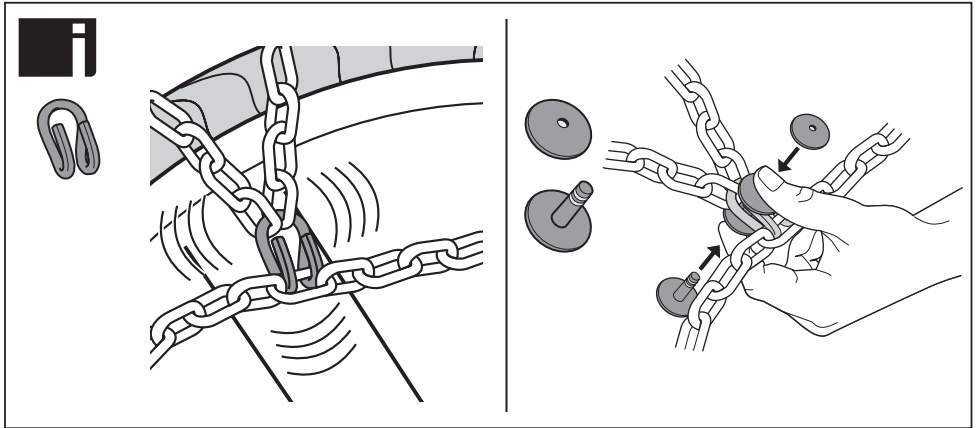



INSTRUCTIONS AND RECOMMENDATIONS FOR USE

1.

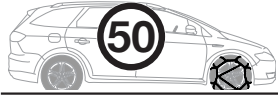

2.

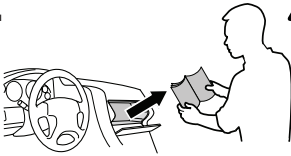

4a

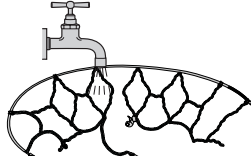

4b

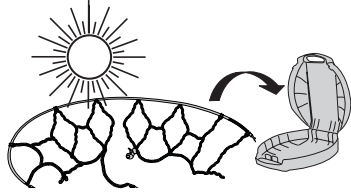

3.

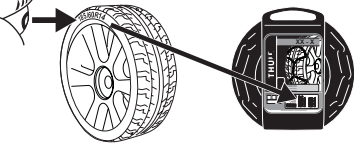

5.

5 *års garanti*
years warranty
Jahre Garantie
ans de garantie

6.

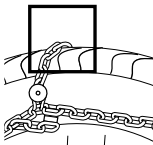

45%





Thule S.p.A Viale Lombardia, 8
23847 Molteno - ITALY
www.thule.com