

FITTING INSTRUCTION

Clamp mark in acc. with		Cables joining
ISO	PN	
1	L	Left directional lights
2	+	Rear fog lights
3	31	Ground
4	R	Right directional lights
5	58R	Right side parking lights
6	54	Stoplights
7	58L	Left side parking lights

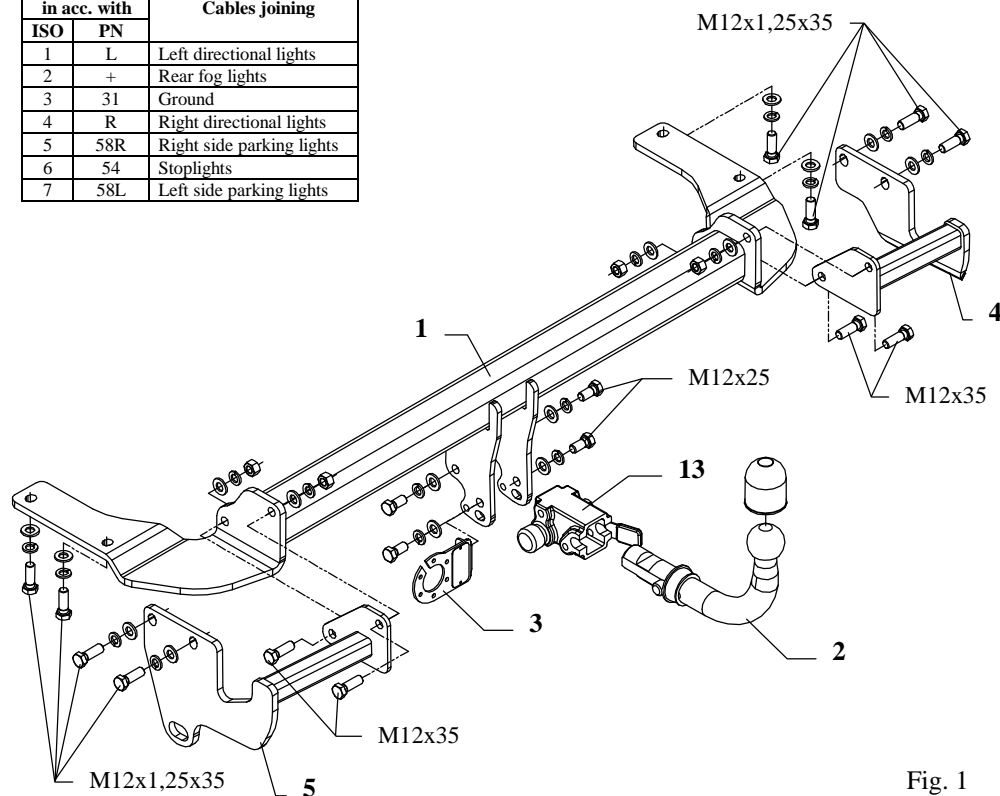

Fig. 1

This towbar is designed to assembly in following cars: **MITSUBISHI GRANDIS**, produced since 2004, catalogue no. **Z34A** and is prepared to tow trailers max total weight **1800 kg** and max vertical load **85 kg**.

From manufacturer

Thank you for buying our product. Their reliability has been confirmed in many tests. Reliability of towbar depends also on correct assembly and right operation. For this reasons we kindly ask to read carefully this instruction and apply to hints.

The towbar should be install in points described by a car producer.

The instruction of the assembly

1. Disassemble the bumper.
2. Cut out the fragment of the bumper as shown on the fig. 2.

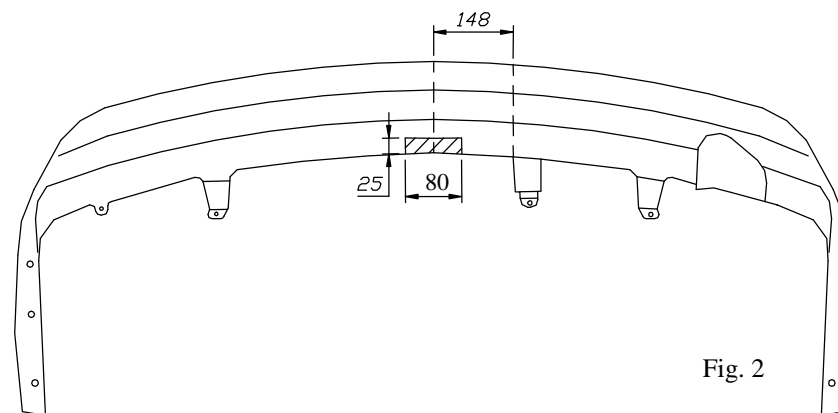

Fig. 2

3. Get lower the back muffler from handles.
4. Unscrew the factory towing eye - will not be assembled again.
5. Fix the main bar of the towbar (pos. 1) to the bottom of the chassis member using bolts M12x1,25x35mm (pos. 8) – loosely.
6. Fix left bracket (pos. 5) to the left chassis member and right bracket (pos. 4) to the right chassis member using bolts M12x1,25x35mm (pos. 8) and fix to the main bar of the towbar (pos. 1) using bolts M12x35mm (pos. 7).
7. Install the bumper and hang up the muffler.
8. Fix body of the automat (pos. 13) and the socket plate (pos. 3) using bolts M12x25mm (pos. 6) from accessories. Place tow-ball (pos. 2) according to supplied instruction.
9. Tighten all bolts according to the torque shown in the table.
10. Connect electric wires of 7-poles socket according to the instruction of the car. (Recommend to make at authorized service station).
11. Complete paint layer damaged during installation.

Torque settings for nuts and bolts (8,8):

M 8 - 25 Nm	M 10 - 55 Nm
M 12 - 85 Nm	M 14 - 135 Nm











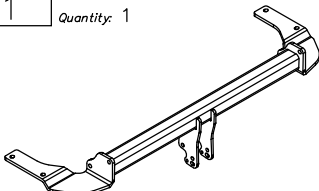
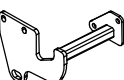

NOTE

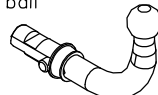
After install the towbar you should get adequate note in registration book (at authorised service station).The car should be equipped with:

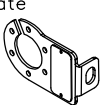
- Indicators
- Tow mirrors

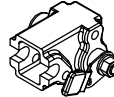
After 1000km check all bolts and nuts. The ball of towbar must be always kept clear and conserve with a grease.

Towbar accessories:

Pos. 1 Name: Main bar Quantity: 1 	Pos. 5 Name: Left bracket cpl. Quantity: 1 	Pos. 10 Name: Plain washer Quantity: 16 Dim.: \varnothing 13 mm 
	Pos. 6 Name: Bolt 8,8 B Quantity: 4 Dim.: M12x25mm 	Pos. 11 Name: Spring washer Quantity: 16 Dim.: \varnothing 12,2 mm 
Pos. 2 Name: Tow ball Quantity: 1 	Pos. 7 Name: Bolt 8,8 B Quantity: 4 Dim.: M12x35mm 	Pos. 12 Name: Ball cover Quantity: 1 
Pos. 3 Name: Socket plate Quantity: 1 	Pos. 8 Name: Bolt 8,8 B Quantity: 8 Dim.: M12x1,25x35mm 	Pos. 13 Name: Body of the automat Quantity: 1 
Pos. 4 Name: Right bracket cpl. Quantity: 1 	Pos. 9 Name: Nut 8 B Quantity: 4 Dim.: M12 	Pos. 14 Name: Body plug Quantity: 1 



PPUH AUTO-HAK S.J.

Produkcja Haków Holowniczych
Henryk & Zbigniew Nejman
76-200 SŁUPSK ul. Słoneczna 16K
tel/fax (059) 8-414-414; 8-414-413
E-mail: office@autohak.com.pl
www.autohak.com.pl

Towing hitch (without electrical set)

Class: A50-X Cat. no. Z34A

Designed for:

Manufacturer: MITSUBISHI

Model: GRANDIS

produced since 2004

Technical data:

D-value: 9,81 kN

maximum trailer weight: 1800 kg

maximum vertical cup load: 85 kg

Approval number according to Directive 94/20/EC: **e20*94/20*0075*00**

Foreword

This towbar is designed according to rules of safety traffic regulations. The towing hitch is a safety component and can be install only by qualified personnel. Any alteration or conversion of the towing hitch is prohibited and would lead to cancellation of design certification. Remove insulating compound and underseal from vehicle (if present) in the area of the matting surfaces of the towing hitch.

The vehicle manufacturer's specifications regarding trailer load and max. vertical cup load are decisive for driving whereat values for the towing hitch cannot be exceeded.

D-value formula:

$$\frac{\text{Max trailer weight [kg]} \times \text{Max vehicle weight [kg]}}{\text{Max trailer weight [kg]} + \text{Max vehicle weight [kg]}} \times \frac{9,81}{1000} = D \text{ [kN]}$$