

FITTING INSTRUCTION

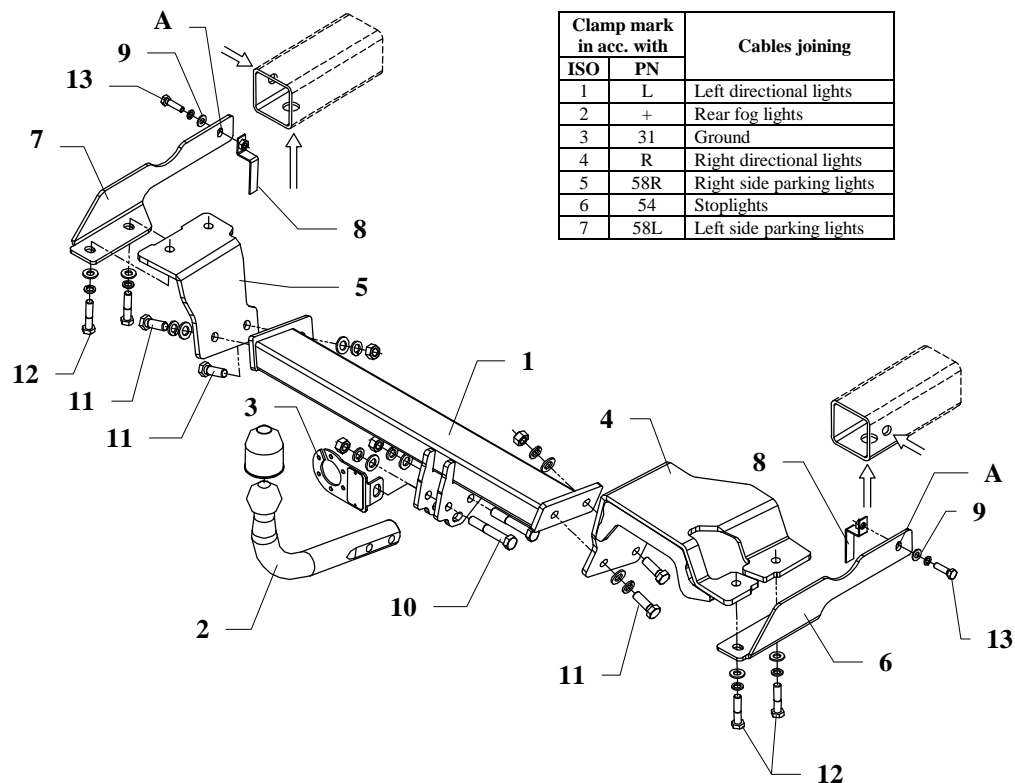

This towbar is designed to assembly in following cars:
Toyota Yaris CP10 (Japanese version), produced since 1999 till 2001 and
Toyota Yaris CP10 (French version), produced since 2002 till 2005,
 catalogue no. **O24** and is prepared to tow trailers max total weight **900 kg**
 and max vertical load **50 kg**.

From manufacturer

Thank you for buying our product. Their reliability has been confirmed in many tests. Reliability of towbar depends also on correct assembly and right operation. For this reasons we kindly ask to read carefully this instruction and apply to hints.

The towbar should be install in points described by a car producer.

The instruction of the assembly

1. Disassemble original tow handles (will not be used any more).
2. Dismount the back muffler and unscrew the thermal shield.
3. Fix loosely elements (pos. 5 and 7) to the left chassis member, as showed on the drawing. Use bolts M10x1,25x45mm (pos. 12) with spring washers.
4. Fix loosely elements (pos. 4 and 6) to the right chassis member, as showed on the drawing. Use bolts M10x1,25x45mm (pos. 12) with spring washers.
5. Slide the main bar of the towbar (pos. 1) between elements (pos. 4 and 5) and fix it with bolts M12x35mm (pos. 11).
6. Tighten all nuts and bolts according to the torque shown in the table.
7. Dismount rear wheels, drill $\varnothing 9\text{mm}$ through holes (pos. A) in the one wall of the car chassis member, fix it using M8x30mm (pos. 13) with the special nuts on the jibs (pos. 8). Slide these nuts underneath car chassis members through original holes.
8. Position the ball of towbar (pos. 2) with socket plate (pos. 3) and fix with bolts M12x75mm (pos. 10) from the towbar accessories.
9. Reassemble the thermal sheet of metal and the muffler.
10. Connect electric wires of 7-poles socket according to the instruction of the car. (Recommend to make at authorized service station).
11. Complete paint layer damaged during installation.

Torque settings for nuts and bolts (8,8):	
M 8 - 25 Nm	M 10 - 55 Nm
M 12 - 85 Nm	M 14 - 135 Nm











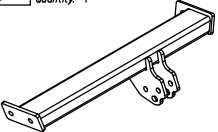

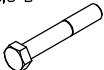







NOTE

After install the towbar you should get adequate registration in registration book (at authorised service station).The car should be equipment with:

- Indicators
- Tow mirrors

After 1000km check all bolts and nuts. The ball of towbar must be always kept clear and conserve with a grease.

Towbar accessories:

Pos. 1 Name: Main bar Quantity: 1 	Pos. 5 Name: Left bracket Quantity: 1 	Pos. 10 Name: Bolt 8,8 B Quantity: 2 Dim.: M12x75mm 	Pos. 15 Name: Plain washer Quantity: 6 Dim.: Ø 13 mm 
	Pos. 6 Name: Right handle Quantity: 1 	Pos. 11 Name: Bolt 8,8 B Quantity: 4 Dim.: M12x35mm 	Pos. 16 Name: Plain washer Quantity: 4 Dim.: Ø 10,5 mm 
Pos. 2 Name: Tow-ball Quantity: 1 	Pos. 7 Name: Left handle Quantity: 1 	Pos. 12 Name: Bolt 8,8 B Quantity: 4 Dim.: M10x1,25x45mm 	Pos. 17 Name: Spring washer Quantity: 6 Dim.: Ø 12,2 mm 
Pos. 3 Name: Socket plate Quantity: 1 	Pos. 8 Name: Nut on the jib Quantity: 2 	Pos. 13 Name: Bolt 8,8 B Quantity: 2 Dim.: M8x30mm 	Pos. 18 Name: Spring washer Quantity: 4 Dim.: Ø 10,2 mm 
Pos. 4 Name: Right bracket Quantity: 1 	Pos. 9 Name: Washer Quantity: 2 Dim.: Ø25xØ9x2mm 	Pos. 14 Name: Nut 8 B Quantity: 4 Dim.: M12 	Pos. 19 Name: Spring washer Quantity: 2 Dim.: Ø 8,2 mm 
			Pos. 20 Name: Ball cover Quantity: 1 



PPUH AUTO-HAK S.J.

Produkcja Haków Holowniczych
Henryk & Zbigniew Nejman
76-200 SŁUPSK ul. Słoneczna 16K
tel/fax (059) 8-414-414; 8-414-413
E-mail: office@autohak.com.pl
www.autohak.com.pl

Towing hitch (without electrical set)

Class: **A50-X** Cat. no. **O24**

Designed for:

Manufacturer: **TOYOTA**

Model: **YARIS**

Type: **CP10**

produced since 1999 till 2001

(Japanese version)

produced since 2002 till 2005

(French version)

Technical data:

D-value: 5,3 kN

maximum trailer weight: **900 kg**

maximum vertical cup load: **50 kg**

Approval number acc. to regulations EKG/ONZ 55.01: E20-55R-01 0730

Foreword

This towbar is designed according to rules of safety traffic regulations. The towing hitch is a safety component and can be install only by qualified personnel. Any alteration or conversion of the towing hitch is prohibited and would lead to cancellation of design certification. Remove insulating compound and underseal from vehicle (if present) in the area of the matting surfaces of the towing hitch.

The vehicle manufacturer's specifications regarding trailer load and max. vertical cup load are decisive for driving, and values for the towing hitch cannot be exceeded.

D-value formula:

$$\frac{\text{Max trailer weight [kg]} \times \text{Max vehicle weight [kg]}}{\text{Max trailer weight [kg]} + \text{Max vehicle weight [kg]}} \times \frac{9,81}{1000} = D \text{ [kN]}$$