

## FITTING INSTRUCTION

Clamp mark in acc. with		Cables joining
ISO	PN	
1	L	Left directional lights
2	+	Rear fog lights
3	31	Ground
4	R	Right directional lights
5	58R	Right side parking lights
6	54	Stoplights
7	58L	Left side parking lights

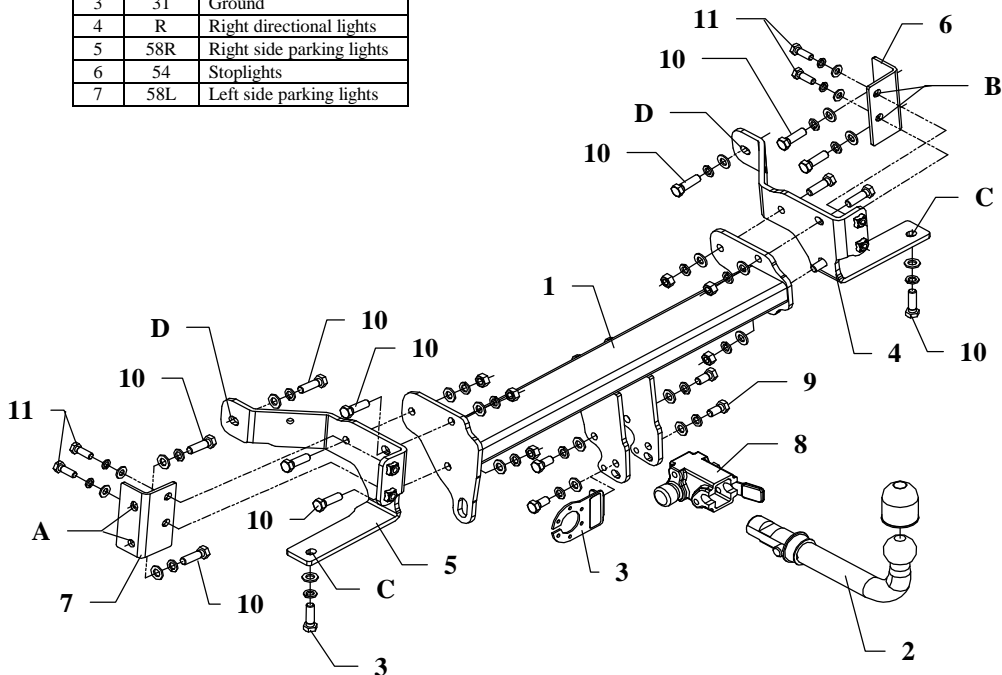

This towing hitch is designed to assembly in following cars:  
**OPEL ANTARA (C105)**, produced since 2006, catalogue number **E51A**  
 and is prepared to tow trailers max total weight up to **2000 kg** and max  
 vertical mass **80 kg**.

### *From manufacturer*

Thank you for buying our product. Their reliability has been confirmed in many tests. Reliability of towing hitch depends also on correct assembly and right operation. For this reasons we kindly ask to read carefully this instruction and apply to hints.

*The towing hitch should be installed in points described by a car producer.*

## The instruction of the assembly

1. Disassemble muffler and last part of exhaust pipe.
2. Disassemble original tow eye (not used any more).
3. Underneath a car find original prepared holes in chassis members and fix loosely (through holes A) angle bars (pos. 6 and 7) using bolts M12x40mm (pos. 10).
4. To installed elements fix loosely through holes B side brackets (pos. 4 and 5) by bolts M10x30mm (pos. 11). Next side brackets fix to the chassis at points C and D by bolts M12x40mm (pos. 10) as shown on the drawing.
5. Between installed side brackets put main bar of the towbar (pos. 1) and fix using bolts M12x40mm (pos. 10) from equipment.
6. Fix body of the automat (pos. 8) and the socket plate (pos. 3) using bolts M12x25mm (pos. 9) from accessories. Place tow-ball (pos. 2) according to supplied instruction.
7. Tighten all bolts according to the torque shown in the table.
8. Reassemble muffler together with last part of exhaust pipe.
9. Connect electric wires of 7-poles socket according to the instruction of the car. (Recommend to do at authorized service station).
10. Complete paint layer damaged during installation.

Torque settings for nuts and bolts (8,8):	
<b>M 8</b> - 25 Nm	<b>M 10</b> - 55 Nm
<b>M 12</b> - 85 Nm	<b>M 14</b> - 135 Nm











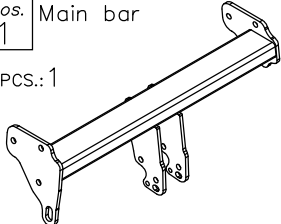

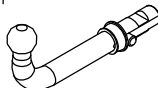
### NOTE

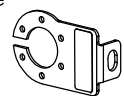
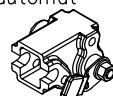
After installation of the towing hitch you should get adequate note in registration book (at authorised service station).The car should be equipped with:

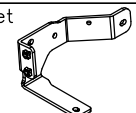
- Indicators
- Tow mirrors

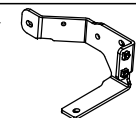
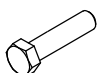
Check all bolts and nuts after **1000 km** of exploitation. The ball of the towing hitch must be always kept clear and conserve with a grease.

Part list:

Pos. 1 Main bar PCS.: 1	Pos. 6 Right angle bar PCS.: 1	Pos. 12 Plain washer Ø13mm PCS.: 18
		
Pos. 2 Tow ball PCS.: 1	Pos. 7 Left angle bar PCS.: 1	Pos. 13 Plain washer Ø10,5mm PCS.: 4
		
Pos. 3 Socket plate PCS.: 1	Pos. 8 Body of the automat PCS.: 1	Pos. 14 Spring washer Ø12,2mm PCS.: 18
		
Pos. 4 Right bracket PCS.: 1	Pos. 9 Bolt 8,8 B M12x25mm PCS.: 4	Pos. 15 Spring washer Ø10,2mm PCS.: 4
		
Pos. 5 Left bracket PCS.: 1	Pos. 10 Bolt 8,8 B M12x40mm PCS.: 14	Pos. 16 Nut 8 B M12 PCS.: 6
		
	Pos. 11 Bolt 8,8 B M10x30mm PCS.: 4	Pos. 17 Ball cover PCS.: 1
		



**PPUH AUTO-HAK S.J.**

Produkcja Haków Holowniczych  
Henryk & Zbigniew Nejman  
76-200 SŁUPSK ul. Słoneczna 16K  
tel/fax (059) 8-414-414; 8-414-413  
E-mail: [office@autohak.com.pl](mailto:office@autohak.com.pl)  
[www.autohak.com.pl](http://www.autohak.com.pl)

**Towing hitch (without electrical set)**

Class: **A50-X** Cat. no. **E51A**

Designed for:

Manufacturer: **OPEL**

Model: **ANTARA**

Type: **(C105)**

produced since 2006

Technical data:

**D-value: 11,0 kN**

maximum trailer weight: **2000 kg**

maximum vertical cup mass: **80 kg**

**Approval number according to Directive 94/20/EC: e20\*94/20\*0524\*00**

**Foreword**

This towing hitch is designed according to rules of safety traffic regulations. The towing hitch is a safety component and can be install only by qualified personnel. Any alteration or conversion of the towing hitch is prohibited and would lead to cancellation of design certification. Remove insulating compound and underseal from vehicle (if present) in the areas of the matting surfaces of the towing hitch. The vehicle manufacturer's specifications regarding trailer load and max. vertical cup mass are decisive for driving whereat values for the towing hitch cannot be exceeded.

*D-value formula:*

$$\frac{\text{Max trailer weight [kg]} \times \text{Max vehicle weight [kg]}}{\text{Max trailer weight [kg]} + \text{Max vehicle weight [kg]}} \times \frac{9,81}{1000} = D \text{ [kN]}$$